

880/890 Series

AUTOMATIC STRIP READING DENSITOMETERS



Control Strip and Balance Print
Format Guide



Proprietary Notice

The information contained in this manual is derived from patent and proprietary data of X-Rite, Incorporated.

The contents of this manual are the property of X-Rite, Incorporated and are copyrighted. Any reproduction in whole or part is strictly prohibited. No part of this manual may be reproduced, transcribed, transmitted, stored in a retrieval system, or translated into any language or computer language, in any form or by any means, electronic, magnetic, mechanical, optical, manual, or otherwise, without the prior written permission of an officer of X-Rite, Incorporated.

Copyright © 2007 X-Rite, Incorporated
"ALL RIGHTS RESERVED"

X-Rite® is a registered trademark of X-Rite, Incorporated
All other logos, product names, registered trademarks, and trademarks mentioned are the property of their respective holders.

General Information

This manual covers important information needed when color paper, film, and printer balance strips are measured.

X-Rite has made attempts to read and document as many control strips as possible. However, there may be certain strips that are not available due to the manufacturers format.

- Section One* - provides a complete listing of all the color paper and film strips the 880/890 series measures. Also shown is the strip insertion direction, field measurement information, and limits.
- Section Two* - lists general format requirements that are needed to correctly measure printer balance bull's-eyes.
- Section Three* - gives a general and detailed description of the printer balance strip formats (White Bull's-eye, Black Bull's-eye, No-Ring Bull's-eye, etc.), that can be measured.
- Section Four* - describes the procedure for properly measuring internegative strips.
- Section Five* - describes the procedure for properly measuring strips without a leader (less than 30.5mm).
- Appendix A* - lists possible causes and solutions if “INVALID READING” is displayed.
- Appendix B* - gives a general description and lists the parameters required to measure generic paper or film strips.

Table of Contents

This manual is organized into five sections and two appendices. In order to make the best use of this document, it is recommended that you review all sections and appendices.

SECTION ONE - Control Strip Formats

Color Paper Category _____	1-1
Agfa AP-63 _____	1-1
Agfa AP-92 _____	1-1
Agfa AP-94 _____	1-2
Agfa AP-95 _____	1-2
Champion EP-2 _____	1-3
Champion RA-4 _____	1-3
Fuji CP-21 _____	1-4
Fuji FA _____	1-4
Fuji R3 _____	1-5
Ilfochrome P-3 _____	1-5
Ilfochrome P-3X _____	1-6
Ilfochrome P-4 _____	1-6
Kodak EP-2 _____	1-7
Kodak RA-4 _____	1-7
Kodak R-3 _____	1-8
Konica CPK _____	1-8
Lucky Film EP-2 _____	1-9
Lucky Film RA-4 _____	1-9
Mitsubishi RA-4 _____	1-10
Russell Chemicals RA _____	1-10
Negative Film Category _____	1-11
Agfa AP-70 _____	1-11
Champion C-41 _____	1-11
Fuji CN-16 _____	1-12
Fuji CN-16Q _____	1-12
Kodak C-41 _____	1-13
Kodak C-41-B / Konica CNK-4 _____	1-14
Kodak KBM _____	1-14
3M C-41 _____	1-15
Mitsubishi NCS _____	1-15
Lucky Film C-41 _____	1-16
Russell Chemicals C41 _____	1-16

TABLE OF CONTENTS

Positive Film Category (882/892 only)	1-17
Agfa AP44	1-17
Fuji E-6	1-17
Kodak E-6	1-18
Kodak E-6 (Used for Q-Lab)	1-19
Kodak Q-Lab	1-19
Ilford P-5	1-20
3M E-6	1-20
SECTION 2 - Printer Balance Requirements	
Rule #1: 30.5mm Strip Leader	2-1
Rule #2: Bull's-Eye & Ring Width Requirements	2-1
Rule #3: Ring/No-Ring	2-2
SECTION 3 - Printer Balance Strip Formats	
Format Overview	3-1
Amplified Format Description	3-3
Black-Eye/White-Eye Explanation	3-3
Single Ring (White or Black Bull's-Eye)	3-3
No-Ring Bull's-Eye	3-4
Kodak 3510 Type	3-6
Small Bull's-Eye	3-7
Print Number Options	3-8
SECTION 4 - Internegative Film Strips (882/892 only)	
Type 1 (4 x 5)	4-1
Type 2 (35mm)	4-3
SECTION 5 - Measuring Leaderless Strips	
APPENDIX A - Strip Measurement Error Messages	
APPENDIX B - Generic Strips	

Control Strip Formats

COLOR PAPER CATEGORY

Agfa AP-63 (Manufactured by Agfa-Gevaert)

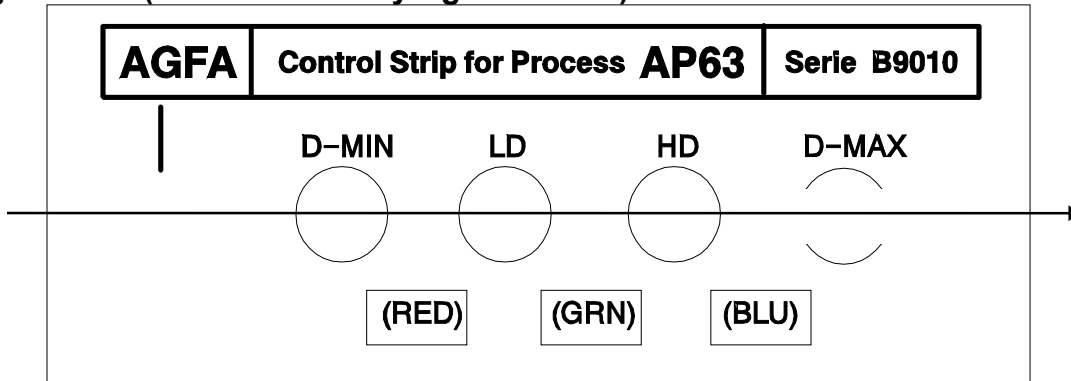

Format: a:AP63

Process: AP-63

Densitometry: Reflection, Status A

Fields Measured	Computed Values	Transformation Rules	Action	Limits		Spread
				Controls		
Field #1 "D-min"	D-min	R1; G1; B1;	—		+ .03	—
Field #2 "LD"	LD	R2; G2; B2;	—		± .12	—
Field #3 "HD"	HD	R3; G3; B3;	—		± .20	—
Field #4 "D-max"	D-max	R4; G4; B4;	—		- .12	—

NOTES:

- 1) Strips must have at least a 1.25" (30.5mm) leader before outside edge of first target, in order for first target to be detected (see Sec. Two).
- 2) -----> Indicates strip pass direction.
- 3) Red, grn, and blu patches are not measured.

Agfa AP-92 (Manufactured by Agfa-Gevaert)

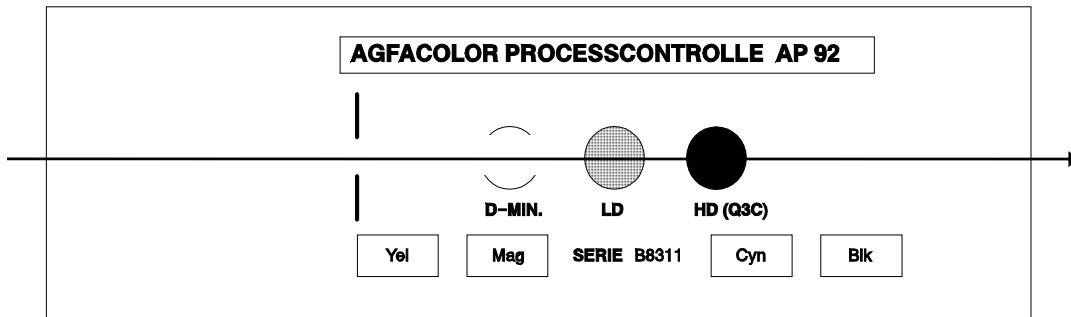

Format: a:AP92

Process: AP-92

Densitometry: Reflection, Status A

Fields Measured	Computed Values	Transformation Rules	Action	Limits		Spread
				Controls		
Field #1 "D-min"	D-min	R1; G1; B1;	—		± .02	—
Field #2 "LD"	LD	R2; G2; B2;	± .07		± .10	—
Field #3 "HD"	HD	R3; G3; B3;	—		± .15	—

NOTES:

- 1) Strips must have at least a 1.25" (30.5mm) leader before outside edge of first target, in order for first target to be detected (see Sec. Two).
- 2) -----> Indicates strip pass direction.
- 3) Yel, Mag, Cyn, and Blk patches are not measured.

Agfa AP-94 (Manufactured by Agfa-Gevaert)

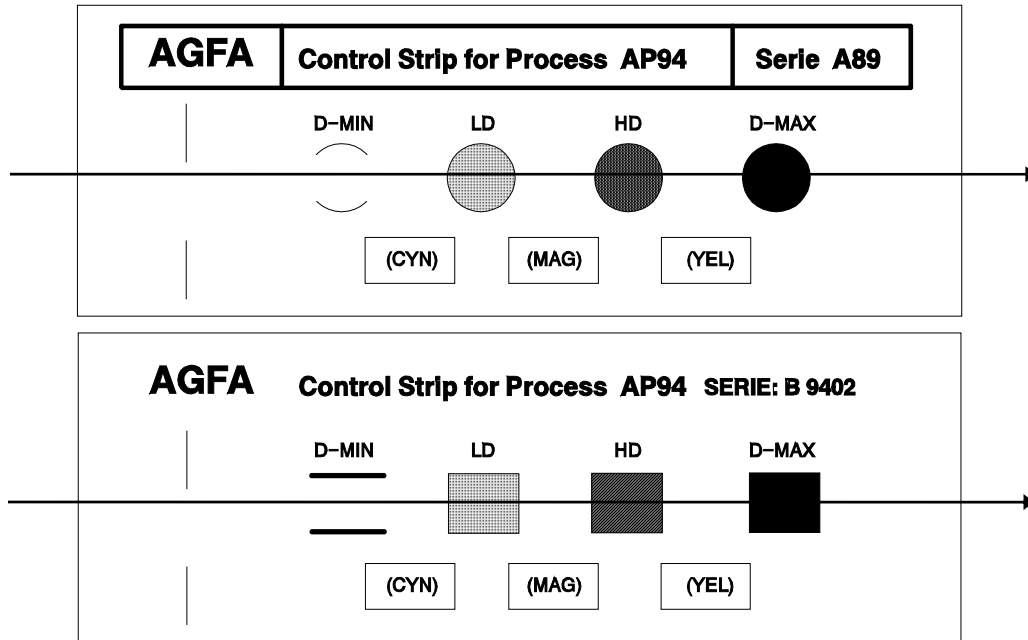

Format: a:AP94

Process: AP-94

Densitometry: Reflection, Status A

Fields Measured	Computed Values	Transformation Rules	Action	Limits		Spread
				Controls		
Field #1 "D-min"	D-min	R1; G1; B1;	+ .02	+ .02	—	—
Field #2 "LD"	LD	R2; G2; B2;	± .10	± .10	—	—
Field #3 "HD"	HD-LD	R3-R2; G3-G2; B3-B2;	± .10	± .10	—	—
Field #4 "D-Max"	D-Max	R4; G4; B4;	-.15	-.15	—	—

NOTES:

- 1) Strips must have at least a 1.25" (30.5mm) leader before outside edge of first target, in order for first target to be detected (see Sec. Two).
- 2) -----> Indicates strip pass direction.
- 3) Cyn, Mag, and Yel patches are not measured.

Agfa AP-95 (Manufactured by Agfa-Gevaert)

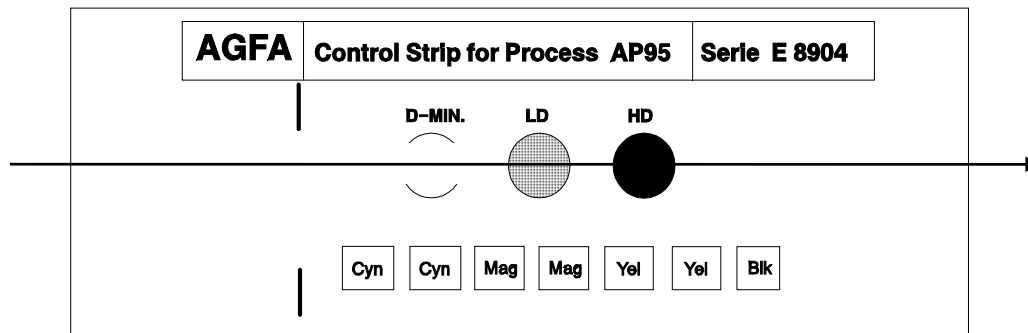

Format: a:AP92

Process: AP-95

Densitometry: Reflection, Status A

Fields Measured	Computed Values	Transformation Rules	Action	Limits		Spread
				Controls		
Field #1 "D-min"	D-min	R1; G1; B1;	—	± .02	—	—
Field #2 "LD"	LD	R2; G2; B2;	± .07	± .10	—	—
Field #3 "HD"	HD	R3; G3; B3;	—	± .15	—	—

NOTES:

- 1) Strips must have at least a 1.25" (30.5mm) leader before outside edge of first target, in order for first target to be detected (see Sec. Two).
- 2) -----> Indicates strip pass direction.
- 3) Yel, mag, cyn, and Blk patches are not measured

Champion EP-2 (Manufactured by Champion Photochemistry)

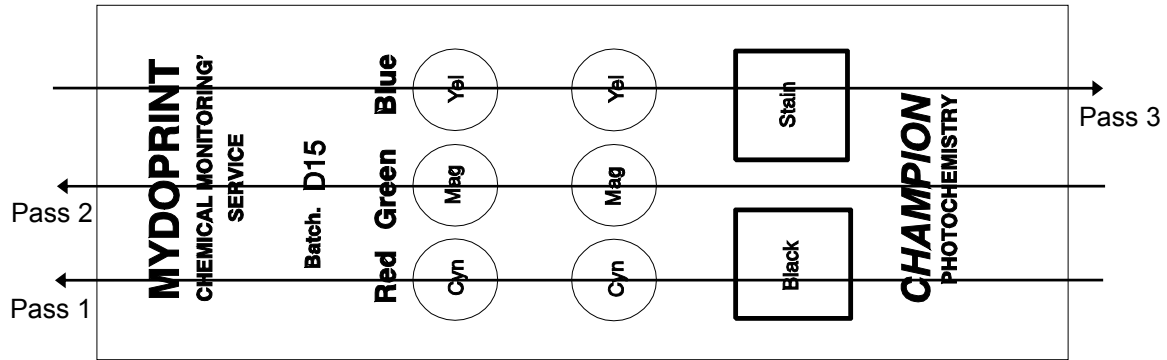

Format: cp:EP2 Process: EP2 Densitometry: Reflection, Status A

Fields Measured	Computed Values	Transformation Rules	Limits		
			Action	Controls	Spread
Field #1 "Stain"	Stain	R1; G1; B1;	—	±.02	—
Field #2 "LD"	Speed	R2; G2; B2;	±.07	±.10	—
Field #3 "HD"	Contr	R3-R2; G3-G2; B3-B2;	±.07	±.10	—
Field #4 "Black"	Black	R4; G4; B4;	—	-.10	—

- NOTES:**
- 1) Strips must have at least a 1.25" (30.5mm) leader before outside edge of first target, in order for first target to be detected (see Sec. Two).
 - 2) -----> Indicates strip pass direction.

Champion RA-4 (Manufactured by Champion Photochemistry)

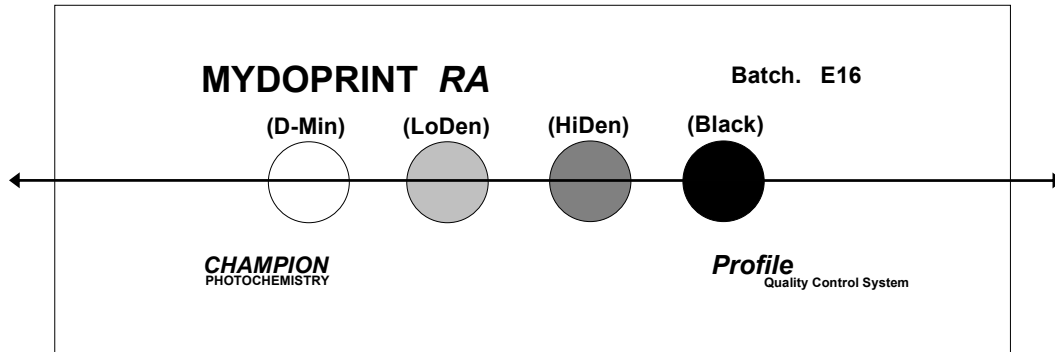

Format: cp:RA-4 Process: RA-4 Densitometry: Reflection, Status A

Fields Measured	Computed Values	Transformation Rules	Limits		
			Action	Controls	Spread
Field #1 "D-min"	D-min	R1; G1; B1;	—	+ .02	—
Field #2 "LoDen"	LoDen	R2; G2; B2;	±.07	±.10	—
Field #3 "HiDen"	HD-LD	R3-R2; G3-G2; B3-B2;	±.07	±.10	—
Field #4 "Black"	Black	R4; G4; B4;	-.10	-.15	—

- NOTES:**
- 1) Strips must have at least a 1.25" (30.5mm) leader before outside edge of first target, in order for first target to be detected (see Sec. Two).
 - 2) <-----> Indicates that strip may be inserted in either direction.

SECTION ONE

Fuji CP-21 (Manufactured by Fuji)

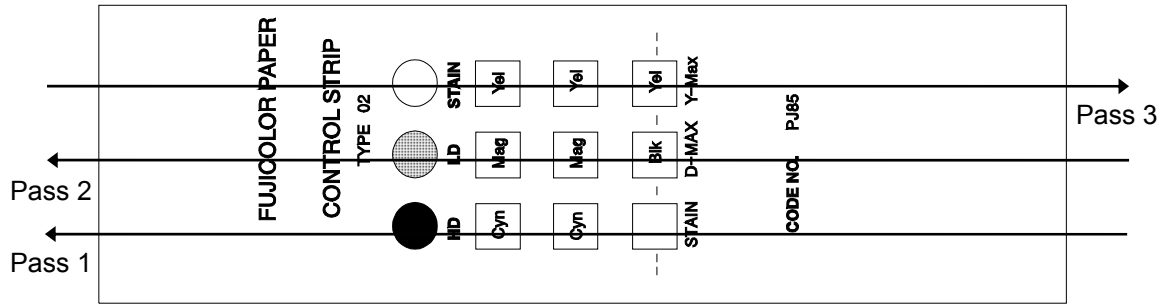

Format: f:CP21

Process: CP-21

Densitometry: Reflection, Status A

Fields Measured	Computed Values	Transformation Rules			Action	Limits	
						Controls	Spread
Field #1 "Stain"	Stain	R1;	G1;	B1;	—	+ .03	—
Field #2 "LD"	LD	R2;	G2;	B2;	± .07	± .10	—
Field #3 "HD"	HD-LD	R3-R2;	G3-G2;	B3-B2;	± .07	± .10	—
Field #4 "D-max"	B-HDc	R4-R3;	;	;	-.10	-.12	—
Field #5 "Y-max"	Yr-Sr	R5-R1;	;	;	—	+ .02	—

NOTES:

- 1) Strips must have at least a 1.25" (30.5mm) leader before outside edge of first target, in order for first target to be detected (see Sec. Two).
- 2) -----> Indicates strip pass direction.
- 3) Round HD, LD, & Stain patches are not measured.

Fuji FA (Manufactured by Fuji)

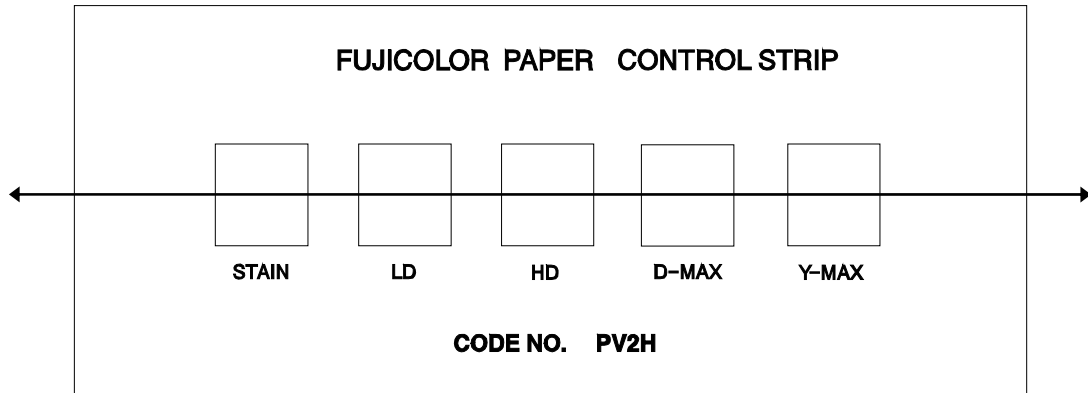

Format: f:FA

Process: FA

Densitometry: Reflection, Status A

Fields Measured	Computed Values	Transformation Rules			Action	Limits	
						Controls	Spread
Field #1 "Stain"	Stain	R1;	G1;	B1;	—	+ .02	—
Field #2 "LD"	LD	R2;	G2;	B2;	—	± .10	—
Field #3 "HD"	HD-LD	R3-R2;	G3-G2;	B3-B2;	—	± .10	—
Field #4 "D-max"	D-max	R4;	G4;	B4;	—	-.10	—
Field #5 "Y-max"	Yr-Sr	R5-R1;	;	;	—	+ .05	—

NOTES:

- 1) Strips must have at least a 1.25" (30.5mm) leader before outside edge of first target, in order for first target to be detected (see Sec. Two).
- 2) <-----> Indicates that strip may be inserted in either direction.
- 3) Round HD, LD, & Stain patches are not measured.

Fuji R-3 (Manufactured by Fuji)

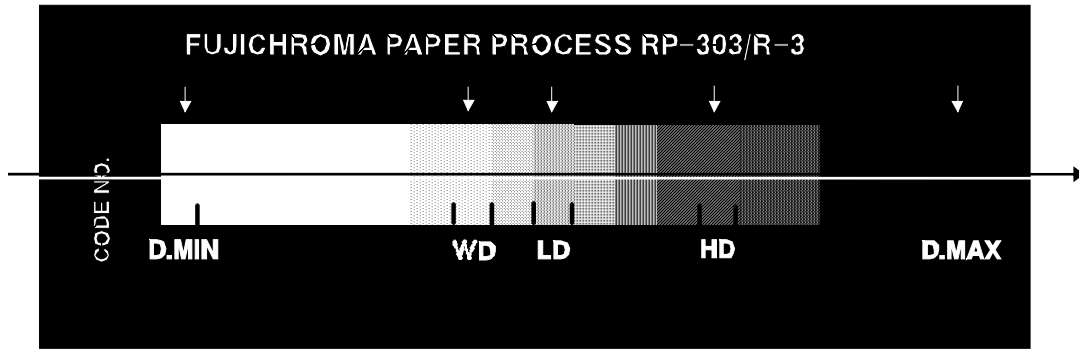

Format: f:R-3		Process: R-3			Densitometry: Reflection, Status A		
Fields Measured	Computed Values	Transformation Rules			Action	Limits	
						Controls	Spread
Field #1 "D-min"	D-min	R1;	G1;	B1;	+ .02	+ .03	—
Field #2 "WD"	WD	R2;	G2;	B2;	—	± .03	—
Field #3 "LD"	LD	R3;	G3;	B3;	± .08	± .10	—
Field #4 "HD"	HD-LD	R4-R3;	G4-G3;	B4-B3;	± .10	± .12	—
Field #5 "D-max"	D-max	R5;	R5;	R5;	-.08	-.12	—

NOTES:

- 1) Strips must have at least a 1.25" (30.5mm) leader before outside edge of first target, in order for first target to be detected (see Sec. Two).
- 2) -----> Indicates strip pass direction.

Ilfochrome P-3 (Manufactured by Ilford)

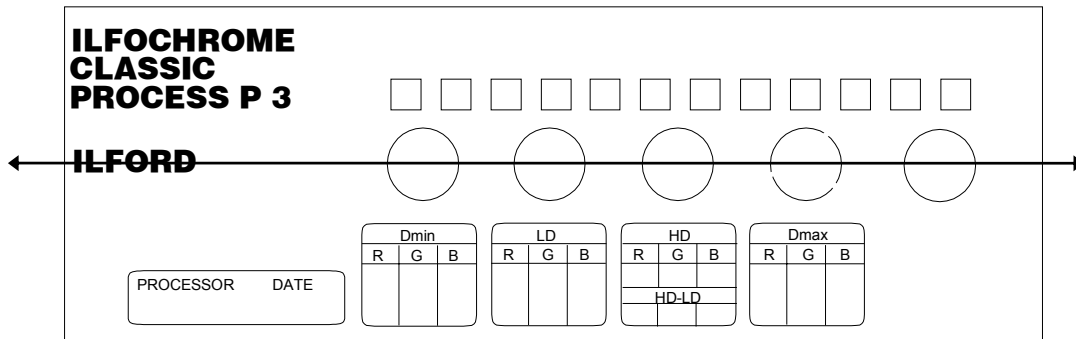

Format: i:P-3		Process: P-3			Densitometry: Reflection, Status A		
Fields Measured	Computed Values	Transformation Rules			Action	Limits	
						Controls	Spread
Field #1 "D-min"	D-min	R1;	G1;	B1;	—	+ .05	—
Field #2 "LD"	LD	R2;	G2;	B2;	—	± .10	—
Field #3 "HD"	HD-LD	R3-R2;	G3-G2;	B3-B2;	—	± .10	—
Field #4 "D-Max"	D-Max	R4;	G4;	B4;	—	-.15	—
Field #5 "Blue"	By-LD	;	;	B5-B2;	—	—	—

NOTES:

- 1) Strips must have at least a 1.25" (30.5mm) leader before outside edge of first target, in order for first target to be detected (see Sec. Two).
- 2) <-----> Indicates that strip may be inserted in either direction.
- 3) Color patches are not measured

Ilfochrome P-3X (Manufactured by Ilford)

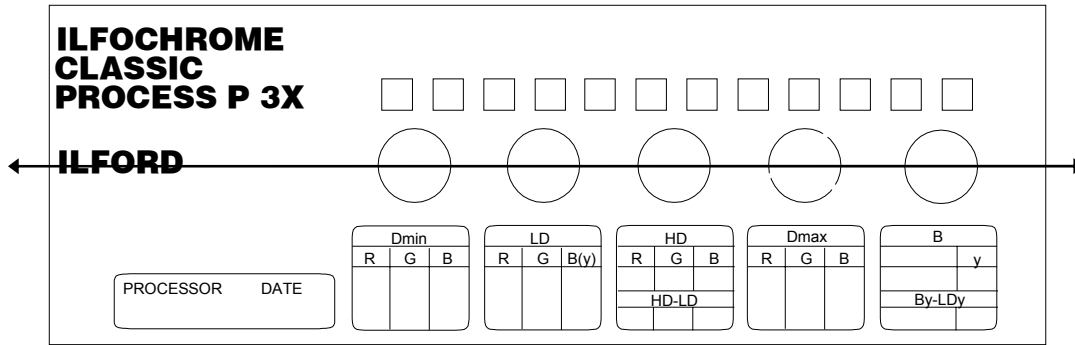

Format: i:P-3X Process: P-3X Densitometry: Reflection, Status A

Fields Measured	Computed Values	Transformation Rules	Action	Limits	
				Controls	Spread
Field #1 "D-min"	D-min	R1; G1; B1;	—	+ .05	—
Field #2 "LD"	LD	R2; G2; B2;	—	± .10	—
Field #3 "HD"	HD-LD	R3-R2; G3-G2; B3-B2;	—	± .10	—
Field #4 "D-Max"	D-Max	R4; G4; B4;	-.10	-.15	—
Field #5 "Blue"	By-LD	; ; B5-B2;	—	± .10	—

- NOTES:
- 1) Strips must have at least a 1.25" (30.5mm) leader before outside edge of first target, in order for first target to be detected (see Sec. Two).
 - 2) ←-----→ Indicates that strip may be inserted in either direction.
 - 3) Color patches are not measured.

Ilfochrome P-4 (Manufactured by Ilford)

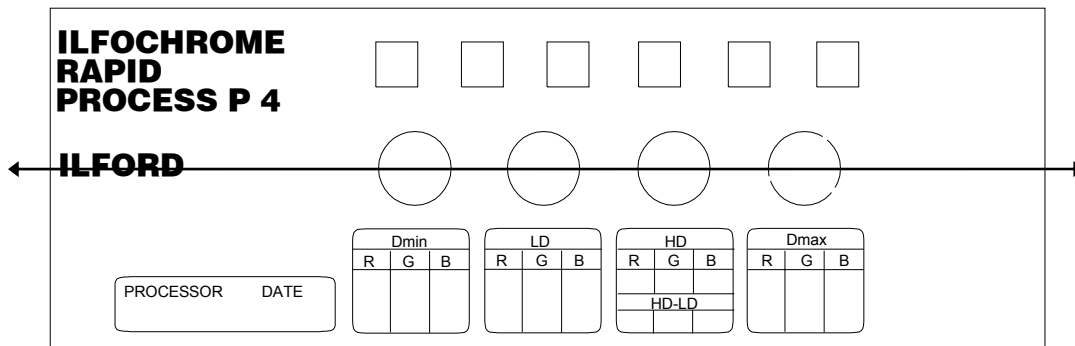

Format: i:P-4 Process: P-4 Densitometry: Reflection, Status A

Fields Measured	Computed Values	Transformation Rules	Action	Limits	
				Controls	Spread
Field #1 "D-Min"	D-Min	R1; G1; B1;	—	+ .05	—
Field #2 "LD"	LD	R2; G2; B2;	—	± .10	—
Field #3 "HD"	HD-LD	R3-R2; G3-G2; B3-B2;	—	± .10	—
Field #4 "Dmax"	Dmax	R4; G4; B4;	—	-.10	—

- NOTES:
- 1) Strips must have at least a 1.25" (30.5mm) leader before outside edge of first target, in order for first target to be detected (see Sec. Two).
 - 2) ←-----→ Indicates that strip may be inserted in either direction.
 - 3) Color patches are not measured.

Kodak EP-2 (Manufactured by Eastman Kodak)

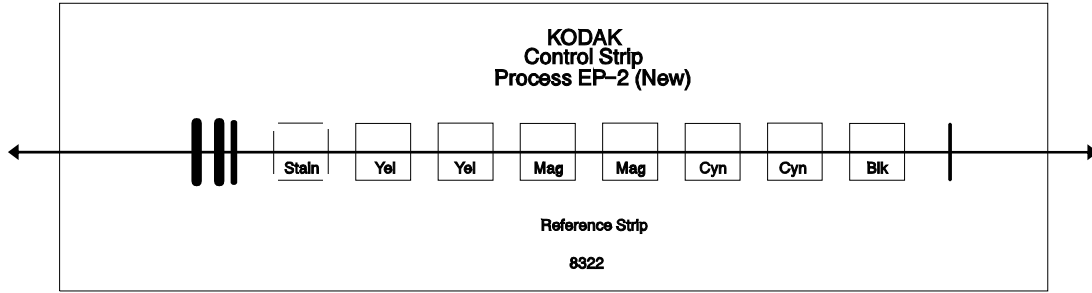

Format: k:EP2/1

Process: EP2

Densitometry: Reflection, Status A

Fields Measured	Computed Values	Transformation Rules	Action	Limits		
				Controls	Spread	
Field #1 "Stain"	Stain	R1; G1; B1;	—	+ .02	—	—
Field #2 "LoDen"	LoDen	R2; G2; B2;	±.07	±.10	—	—
Field #3 "HiDen"	HD-LD	R3-R2; G3-G2; B3-B2;	±.07	±.10	—	—
Field #4 "Black"	Black	R4; ; ;	—	-.15	—	—
Field #5	B-HDc	R4-R3; ; ;	—	±.10	—	—

NOTES:

- 1) Strips must have at least a 1.25" (30.5mm) leader before outside edge of first target, in order for first target to be detected (see Sec. Two).
- 2) ←-----→ Indicates that strip may be inserted in either direction.

Kodak RA-4 (Manufactured by Eastman Kodak)

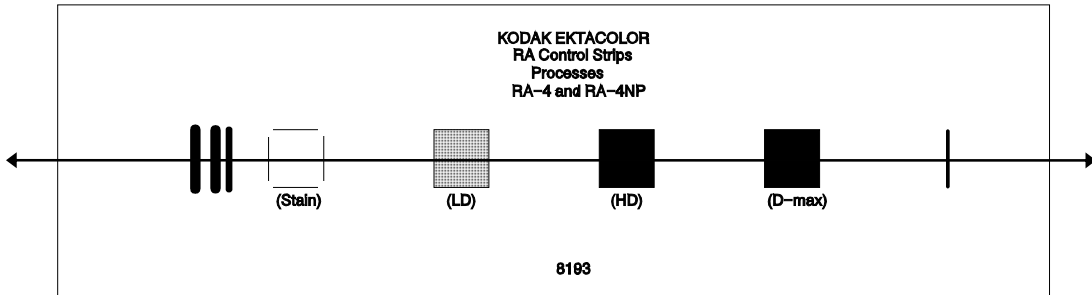

Format: k:RA-4

Process: RA-4

Densitometry: Reflection, Status A

Fields Measured	Computed Values	Transformation Rules	Action	Limits		
				Controls	Spread	
Field #1 "D-min"	D-min	R1; G1; B1;	—	+ .02	—	—
Field #2 "LoDen"	LoDen	R2; G2; B2;	±.07	±.10	—	—
Field #3 "HiDen"	HD-LD	R3-R2; G3-G2; B3-B2;	±.07	±.10	—	—
Field #4 "Black"	Black	R4; G4; B4;	-.10	-.15	—	—

NOTES:

- 1) Strips must have at least a 1.25" (30.5mm) leader before outside edge of first target, in order for first target to be detected (see Sec. Two).
- 2) ←-----→ Indicates that strip may be inserted in either direction.

Kodak R-3 (Manufactured by Eastman Kodak)

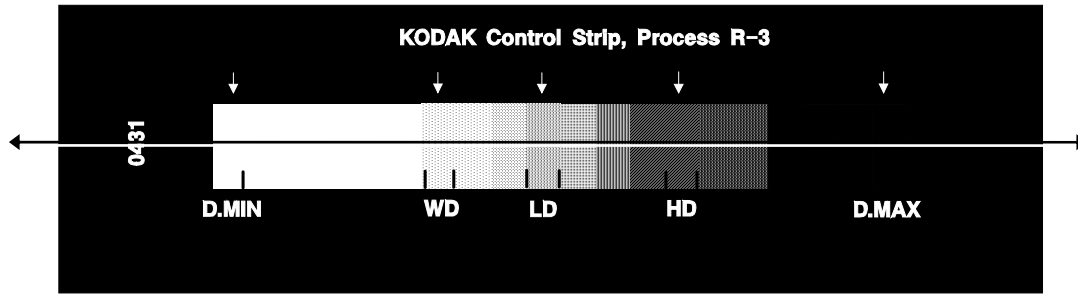

Format: k:R-3		Process: R-3			Densitometry: Reflection, Status A		
Fields Measured	Computed Values	Transformation Rules			Action	Limits	
						Controls	Spread
Field #1 "D-min"	D-min	R1;	G1;	B1;	—	—	—
Field #2 "WD"	WD	R2;	G2;	B2;	—	—	—
Field #3 "LD"	LD	R3;	G3;	B3;	±.08	±.12	—
Field #4 "HD"	HD-LD	R4-R3;	G4-G3;	B4-B3;	±.08	±.12	—
Field #5 "D-max"	D-max	R5;	R5;	R5;	-.08	-.12	—

- NOTES:**
 1) Strips must have at least a 1.25" (30.5mm) leader before outside edge of first target, in order for first target to be detected (see Sec. Two).
 2) ←-----→ Indicates that strip may be inserted in either direction.

Konica CPK (Manufactured by Konica)

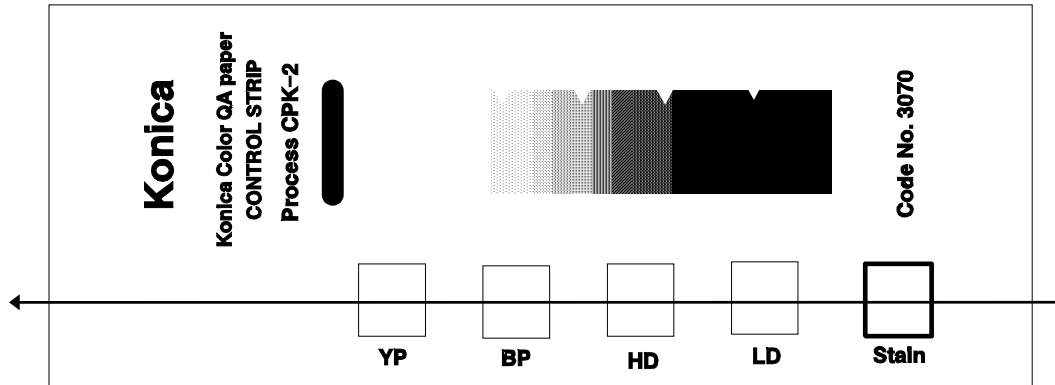

Format: k:CPK		Process: CPK			Densitometry: Reflection, Status A		
Fields Measured	Computed Values	Transformation Rules			Action	Limits	
						Controls	Spread
Field #1 "Stain"	Stain	R1;	G1;	B1;	—	+ .02	—
Field #2 "LD"	LD	R2;	G2;	B2;	±.07	±.10	—
Field #3 "HD"	HD-LD	R3-R2;	G3-G2;	B3-B2;	±.07	±.10	—
Field #4 "BP"	BP	R4;	G4;	B4;	—	—	—
Field #5 "Y-max"	Yr-Sr	R5-R1;	;	;	—	-.10	—

- NOTES:**
 1) Strips must have at least a 1.25" (30.5mm) leader before outside edge of first target, in order for first target to be detected (see Sec. Two).
 2) -----→ Indicates strip pass direction.
 3) Step wedge not measured.

Lucky Film EP-2 (Manufactured by Lucky Film Limited)

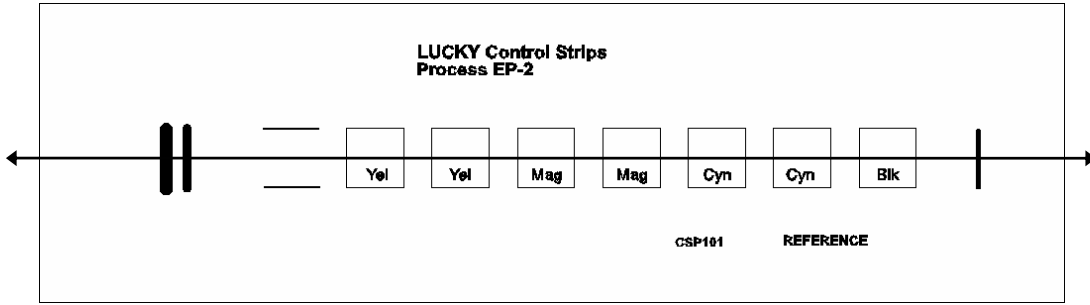

Format: LK:EP-2

Process: EP-2

Densitometry: Reflection, Status A

Fields Measured	Computed Values	Transformation Rules	Action	Limits	
				Controls	Spread
Field #1 "D-min"	D-min	R1; G1; B1;	—	±.02	—
Field #2 "LD"	LD	R2; G2; B2;	±.07	±.10	—
Field #3 "HD"	HD-LD	R3-R2; G3-G2; B3-B2;	±.07	±.10	—
Field #4 "Black"	Black	R4; G4; B4;	-.10	-.15	—
Field #5 "YelHD"	Yr-Sr	R5-R1; ; ;	—	±.06	—

NOTES:

- 1) Strips must have at least a 1.25" (30.5mm) leader before outside edge of first target, in order for first target to be detected (see Sec. Two).
- 2) ←-----→ Indicates that strip may be inserted in either direction.

Lucky Film RA-4 (Manufactured by Lucky Film Limited)

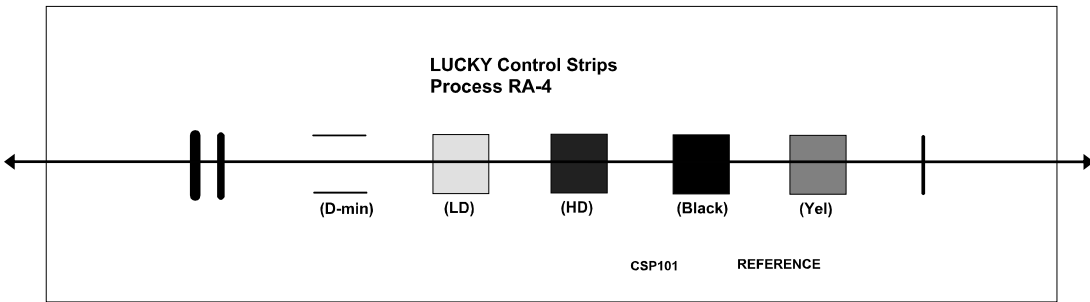

Format: LK:RA-4

Process: RA-4

Densitometry: Reflection, Status A

Fields Measured	Computed Values	Transformation Rules	Action	Limits	
				Controls	Spread
Field #1 "D-min"	D-min	R1; G1; B1;	—	±.02	—
Field #2 "LD"	LD	R2; G2; B2;	±.07	±.10	—
Field #3 "HD"	HD-LD	R3-R2; G3-G2; B3-B2;	±.07	±.10	—
Field #4 "Black"	Black	R4; G4; B4;	-.10	-.15	—
Field #5 "Yel"	Yr-Sr	R5-R1; ; ;	—	+06	—

NOTES:

- 1) Strips must have at least a 1.25" (30.5mm) leader before outside edge of first target, in order for first target to be detected (see Sec. Two).
- 2) ←-----→ Indicates that strip may be inserted in either direction.

Mitsubishi RA-4 (Manufactured by Mitsubishi)

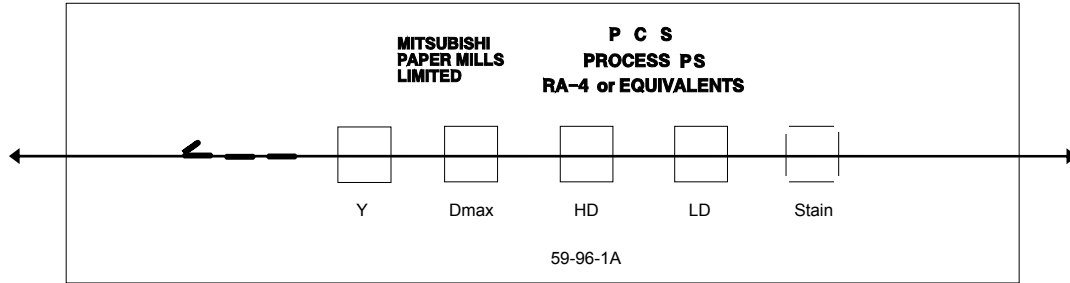

Format: m:RA-4 Process: RA-4 Densitometry: Reflection, Status A

Fields Measured	Computed Values	Transformation Rules	Action	Limits	
				Controls	Spread
Field #1 "D-min"	D-min	R1; G1; B1;	—	+ .02	—
Field #2 "LD"	LD	R2; G2; B2;	—	± .10	—
Field #3 "HD"	HD-LD	R3-R2; G3-G2; B3-B3;	—	± .10	—
Field #4 "D-Max"	D-Max	R4; G4; B4;	—	—	—

- NOTES:**
- 1) Strips must have at least a 1.25" (30.5mm) leader before outside edge of first target, in order for first target to be detected (see Sec. Two).
 - 2) ←-----→ Indicates that strip may be inserted in either direction.

Russell Chemicals RA (Manufactured by L.B. Russell Chemicals)

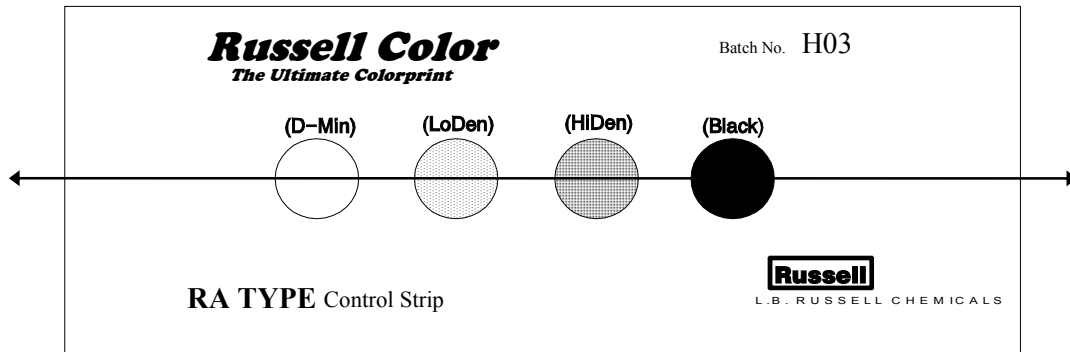

Format: rc:RA Process: RA Densitometry: Reflection, Status A

Fields Measured	Computed Values	Transformation Rules	Action	Limits	
				Controls	Spread
Field #1 "D-min"	D-min	R1; G1; B1;	—	+ .02	—
Field #2 "LoDen"	LoDen	R2; G2; B2;	—	± .10	—
Field #3 "HiDen"	HD-LD	R3-R2; G3-G2; B3-B2;	—	± .10	—
Field #4 "Black"	Black	R4; G4; B4;	- .10	- .15	—

- NOTES:**
- 1) Strips must have at least a 1.25" (30.5mm) leader before outside edge of first target, in order for first target to be detected (see Sec. Two).
 - 2) ←-----→ Indicates that strip may be inserted in either direction.

NEGATIVE FILM CATEGORY

Agfa AP-70 (Manufactured by Agfa-Gevaert)

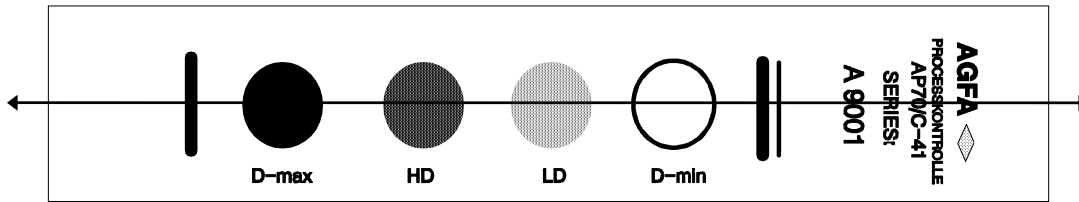

Format: a:AP70

Process: AP70

Densitometry: Transmission, Status M

Fields Measured	Computed Values	Transformation Rules	Action	Limits	
				Controls	Spread
Field #1 "D-min"	D-min	R1; G1; B1;	±.06	+ .06	—
Field #2 "LD"	LD-Dm	R2-R1; G2-G1; B2-B1;	±.08	±.08	—
Field #3 "HD"	HD-LD	R3-R2; G3-G2; B3-B2;	±.09	±.09	.09
Field #4 "D-max"	Xb-Hb	; ; B4-B3;	+ .15	+ .15	—
Field #5	Xr-Xg	R4-G4; ; ;	-.25	-.25	—

NOTES:

- 1) Strips must have at least a 1.25" (30.5mm) leader before outside edge of first target, in order for first target to be detected (see Sec. Two).
- 2) ←-----→ Indicates that strip may be inserted in either direction.

Champion C-41 (Manufactured by Champion Chemistry)

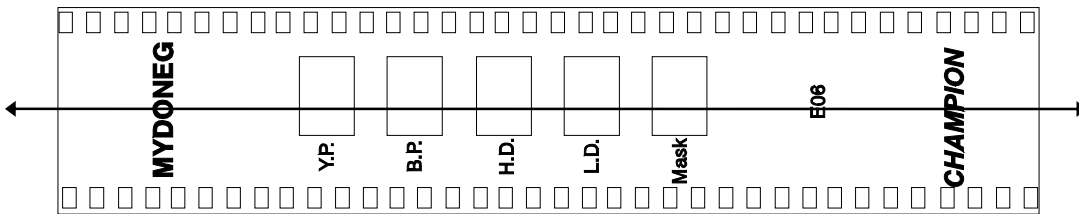

Format: cp:C41

Process: C-41

Densitometry: Transmission, Status M

Fields Measured	Computed Values	Transformation Rules	Action	Limits	
				Controls	Spread
Field #1 "Mask"	Mask	R1; G1; B1;	+ .03	+ .05	—
Field #2 "LoDen"	LoDen	R2; G2; B2;	±.06	±.08	—
Field #3 "HiDen"	HD-LD	R3-R2; G3-G2; B3-B2;	±.07	±.09	.09
Field #4 "D-max"	Xb-Yb	; ; B4-B5;	+ .10	±.12	—
Field #5 "Yel"		; ; ;	—	—	—

NOTES:

- 1) Strips must have at least a 1.25" (30.5mm) leader before outside edge of first target, in order for first target to be detected (see Sec. Two).
- 2) ←-----→ Indicates that strip may be inserted in either direction.

Fuji CN-16 (Manufactured by Fuji)

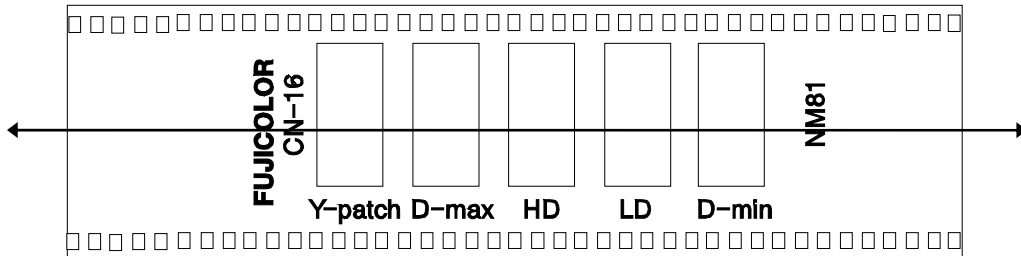

Format: f:CN16		Process: CN-16			Densitometry: Transmission, Status M		
Fields Measured		Computed Values		Transformation Rules		Limits	
				Action	Controls	Spread	
Field #1 "D-min"	D-min	R1;	G1;	B1;	±.03	±.06	—
Field #2 "LD"	LD	R2;	G2;	B2;	±.06	±.08	—
Field #3 "HD"	HD-LD	R3-R2;	G3-G2;	B3-B2;	±.07	±.09	.09
Field #4 "D-max"	Xb-Yb	;	;	B4-B5;	+ .10	+ .12	—
Field #5 "Yel"	Xr-Xg	R4-G4;	;	;	—	—	—

- NOTES:**
 1) Strips must have at least a 1.25" (30.5mm) leader before outside edge of first target, in order for first target to be detected (see Sec. Two).
 2) ←-----→ Indicates that strip may be inserted in either direction.

Fuji CN-16Q (Manufactured by Fuji)

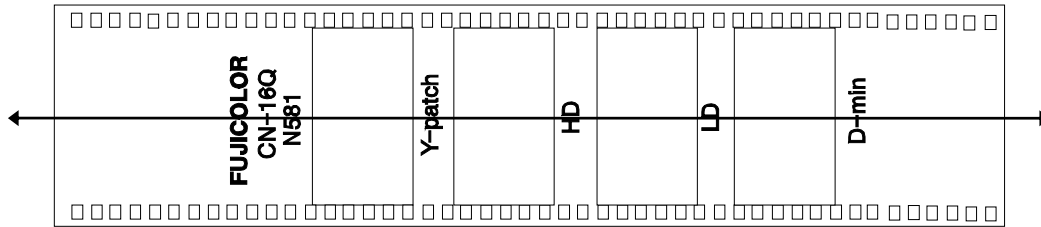

Format: f:CN16Q		Process: CN-16Q			Densitometry: Transmission, Status M		
Fields Measured		Computed Values		Transformation Rules		Limits	
				Action	Controls	Spread	
Field #1 "D-min"	D-min	R1;	G1;	B1;	—	±.05	—
Field #2 "LD"	LD	R2;	G2;	B2;	—	±.08	—
Field #3 "HD"	HD-LD	R3-R2;	G3-G2;	B3-B2;	—	±.09	—
Field #4 "Yel"	Yel	;	;	;	—	+ .12	—

- NOTES:**
 1) Strips must have at least a 1.25" (30.5mm) leader before outside edge of first target, in order for first target to be detected (see Sec. Two).
 2) ←-----→ Indicates that strip may be inserted in either direction.

Kodak C-41 (Manufactured by Eastman Kodak)

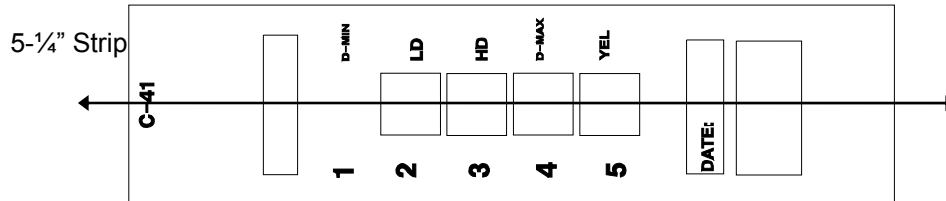
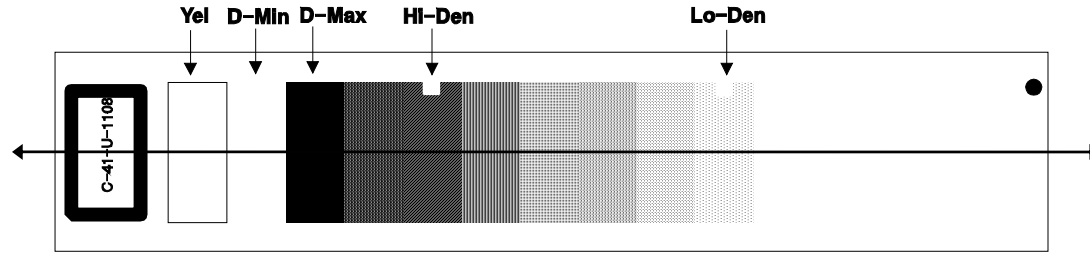
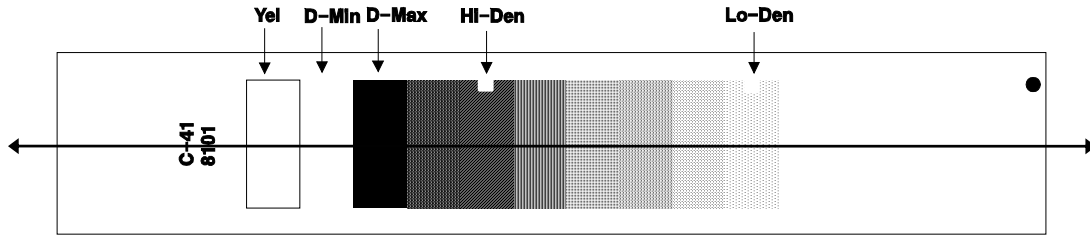

9-1/4" Strip

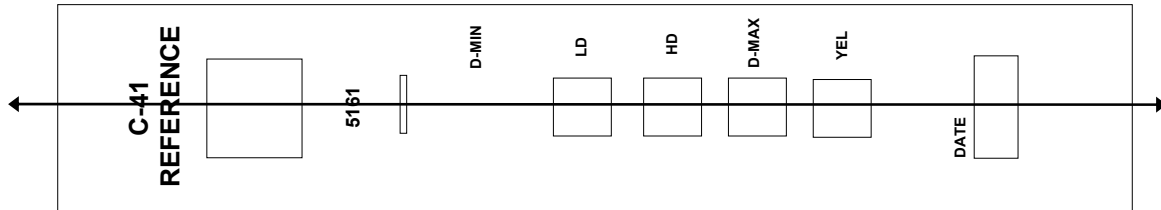

Format: k:C41

Process: C-41

Densitometry: Transmission, Status M

Fields Measured	Computed Values	Transformation Rules	Action	Limits	
				Controls	Spread
Field #1 "D-min"	D-min	R1; G1; B1;	+03	+05	—
Field #2 "LoDen"	LoDen	R2; G2; B2;	±06	±08	—
Field #3 "HiDen"	HD-LD	R3-R2; G3-G2; B3-B2;	±07	±09	.09
Field #4 "D-max"	Xb-Yb	; ; B4-B5;	+10	±12	—
Field #5 "Yel"	Xr-Xg	R4-G4; ; ;	-.20	-.25	—

NOTES:

- 1) Strips must have at least a 1.25" (30.5mm) leader before outside edge of first target, in order for first target to be detected (see Sec. Two).
- 2) ←-----→ Indicates that strip may be inserted in either direction.
- 3) The D-min measurement is taken between the yellow and D-max patches. This does not apply to the 5-1/4" strip.

Kodak C-41-B (Manufactured by Eastman Kodak)

NOTE: If "k:C-41-B" strip format does not appear in the film category of your instrument, measure the strip under the "CNK-4" strip format.

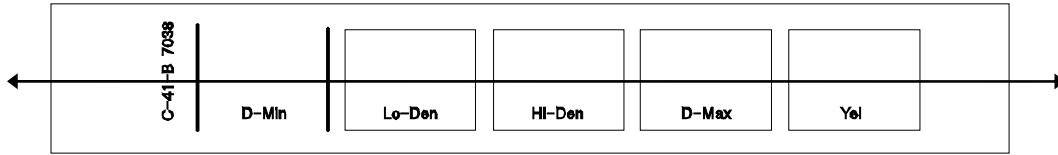

Konica CNK-4 (Manufactured by Konica)

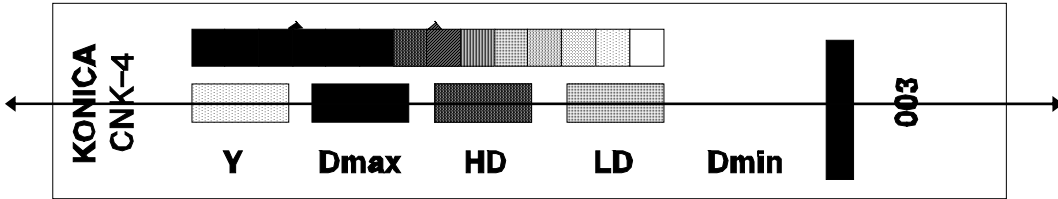

Format: C-41-B/CNK-4 Process: C-41-B/CNK-4 Densitometry: Transmission, Status M

Fields Measured	Computed Values	Transformation Rules	Action	Limits		Spread
				Controls	Spread	
Field #1 "D-min"	D-min	R1; G1; B1;	+ .03	+ .05	—	—
Field #2 "LoDen"	LoDen	R2; G2; B2;	± .06	± .08	—	—
Field #3 "HiDen"	HD-LD	R3-R2; G3-G2; B3-B2;	± .07	± .09	.09	—
Field #4 "D-max"	Xb-Yb	; ; B4-B5;	+ .10	+ .12	—	—
Field #5 "Yel"		; ; ;	—	—	—	—

NOTES:

- 1) Strips must have at least a 1.25" (30.5mm) leader before outside edge of first target, in order for first target to be detected (see Sec. Two).
- 2) ←-----→ Indicates that strip may be inserted in either direction.
- 3) Step wedge not measured on CNK-4.

Kodak KBM (Manufactured by Eastman Kodak)

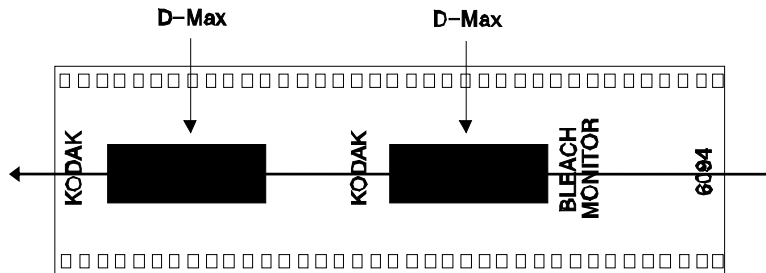

Format: k:KBM Process: KBM Densitometry: Transmission, Status M

Fields Measured	Computed Values	Transformation Rules	Action	Limits		Spread
				Controls	Spread	
Field #1 "D-max"	Xr-Xg	R1-G1; ; ;	-.20	-.25	—	—

NOTES:

- 1) Strips must have at least a 1.25" (30.5mm) leader before outside edge of first target, in order for first target to be detected (see Sec. Two).
- 2) ←-----→ Indicates that strip may be inserted in either direction.
- 3) On KBM strip, data is taken from the 1st D-max patch to enter densitometer (leader excluded).

3M C-41 (Manufactured by 3M)

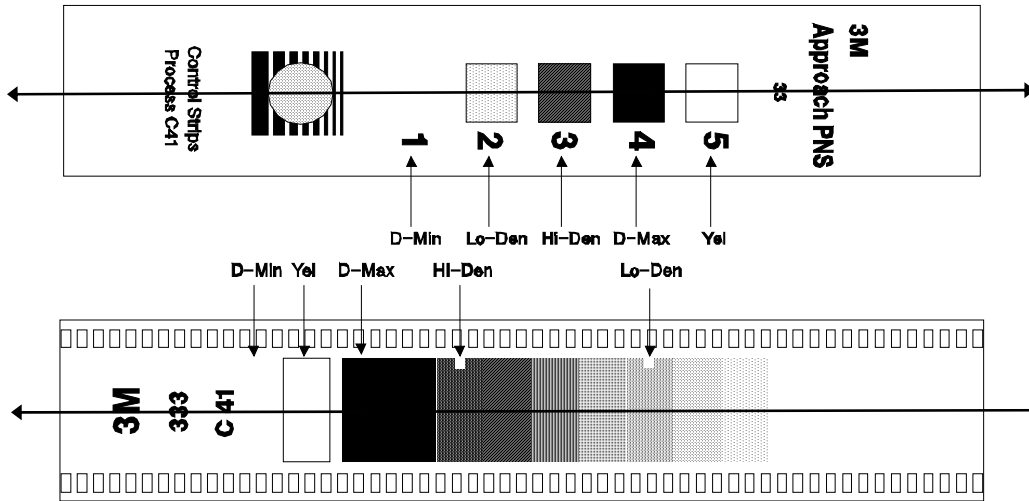

Format: 3m:C41

Process: C-41

Densitometry: Transmission, Status M

Fields Measured	Computed Values	Transformation Rules	Action	Limits	
				Controls	Spread
Field #1 "D-min"	D-min	R1; G1; B1;	+ .03	+ .05	—
Field #2 "LoDen"	LoDen	R2; G2; B2;	± .06	± .08	—
Field #3 "HiDen"	HD-LD	R3-R2; G3-G2; B3-B2;	± .07	± .09	.09
Field #4 "D-max"	Xb-Yb	; ; B4-B5;	+ .10	± .12	—
Field #5 "Yel"		; ; ;	—	—	—

NOTES:

- 1) Strips must have at least a 1.25" (30.5mm) leader before outside edge of first target, in order for first target to be detected (see Sec. Two).
- 2) ←-----→ Indicates that strip may be inserted in either direction.
- 3) The D-min measurement is taken before the yellow patch.

Mitsubishi NCS (Manufactured by Mitsubishi)

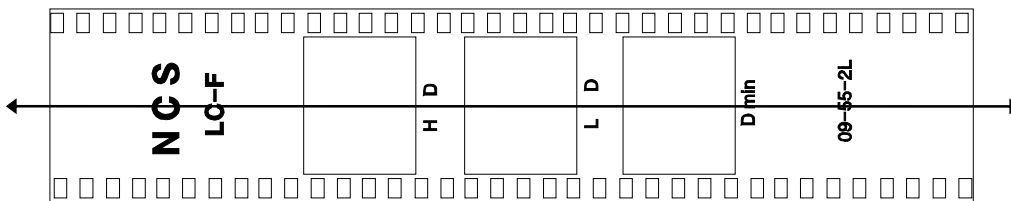

Format: m:NCS

Process: NCS

Densitometry: Transmission, Status M

Fields Measured	Computed Values	Transformation Rules	Action	Limits	
				Controls	Spread
Field #1 "D-min"	D-min	R1; G1; B1;	—	± .05	—
Field #2 "LoDen"	LoDen	R2; G2; B2;	—	± .08	—
Field #3 "HiDen"	HD-LD	R3-R2; G3-G2; B3-B2;	—	± .08	—

NOTES:

- 1) Strips must have at least a 1.25" (30.5mm) leader before outside edge of first target, in order for first target to be detected (see Sec. Two).
- 2) ←-----→ Indicates that strip may be inserted in either direction.

Lucky Film C-41 (Manufactured by Lucky Film Limited)

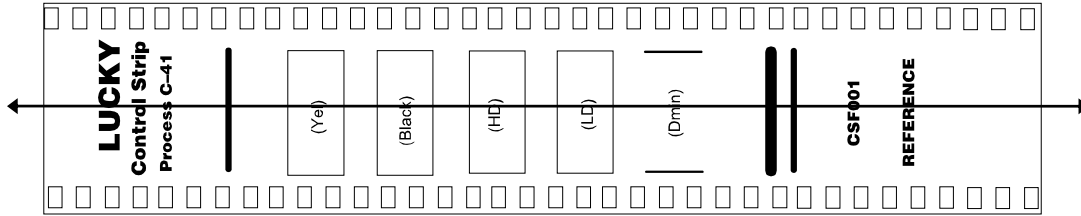

Format: LK:C-41		Process: C-41			Densitometry: Transmission, Status M		
					Limits		
Fields Measured	Computed Values	Transformation Rules			Action	Controls	Spread
Field #1 "D-min"	D-min	R1;	G1;	B1;	±.03	+ .05	—
Field #2 "LD"	LD	R2;	G2;	B2;	±.06	±.08	—
Field #3 "HD"	HD-LD	R3-R2;	G3-G2;	B3-B2;	±.07	±.09	.09
Field #4 "Black"	Xb-Yb	;	;	B4-B5;	±.10	±.12	—
Field #5 "Yel"	Xr-Xg	R4-G4;	;	;	±.20	±.25	—

- NOTES:**
 1) Strips must have at least a 1.25" (30.5mm) leader before outside edge of first target, in order for first target to be detected (see Sec. Two).
 2) ←-----→ Indicates that strip may be inserted in either direction.

Russell Chemicals C-41 (Manufactured by Russell Chemical)

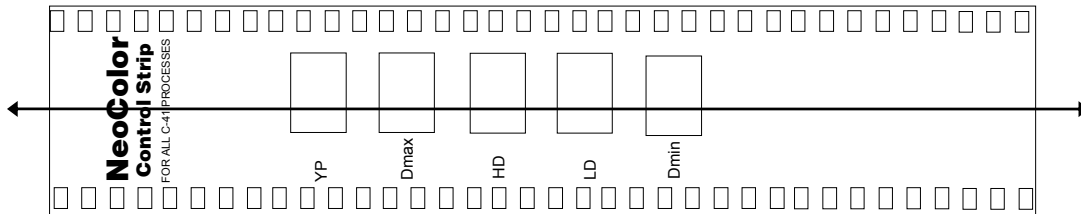

Format: rc:C41		Process: C-41			Densitometry: Transmission, Status M		
					Limits		
Fields Measured	Computed Values	Transformation Rules			Action	Controls	Spread
Field #1 "D-min"	D-min	R1;	G1;	B1;	+ .03	+ .05	—
Field #2 "LoDen"	LoDen	R2;	G2;	B2;	±.06	±.08	—
Field #3 "HiDen"	HD-LD	R3-R2;	G3-G2;	B3-B2;	±.07	±.09	.09
Field #4 "D-max"	Xb-Yb	;	;	B4-B5;	±.10	±.12	—
Field #5 "Yel"		;	;	;	—	—	—

- NOTES:**
 1) Strips must have at least a 1.25" (30.5mm) leader before outside edge of first target, in order for first target to be detected (see Sec. Two).
 2) ←-----→ Indicates that strip may be inserted in either direction.

POSITIVE FILM CATEGORY (882/892 ONLY)

Agfa AP-44 (Manufactured by Agfa-Gevaert)

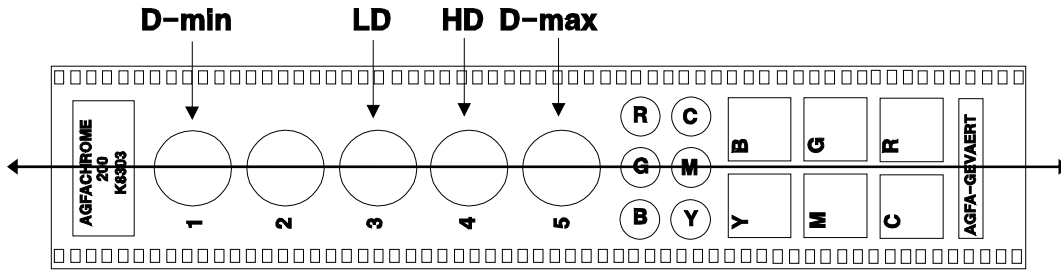

Format: a:AP44

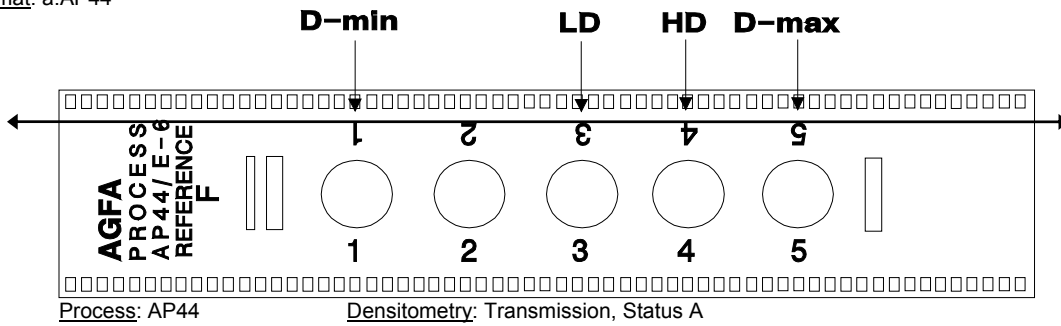

Fields Measured	Computed Values	Transformation Rules	Action	Limits	Spread
Field #1 "D-Min"	D-Min	R1; G1; B1;	—	+ .05	—
Field #2 "LD"	LD	R2; G2; B2;	—	± .10	.08
Field #3 "HD"	HD	R3; G3; B3;	—	± .15	.13
Field #4 "D-Max"	D-Max	R4; G4; B4;	—	- .20	—

NOTES:

- 1) Strips must have at least a 1.25" (30.5mm) leader before outside edge of first target, in order for first target to be detected (see Sec. Two).
- 2) ←-----→ Indicates that strip may be inserted in either direction.
- 3) Small color patches are not measured.

Fuji E-6 (Manufactured by Fuji)

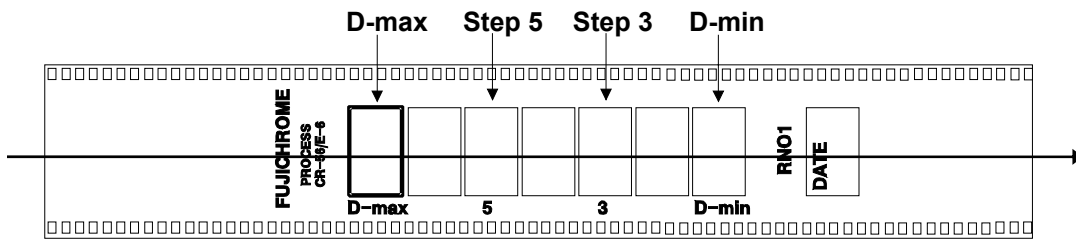

Format: f:E-6

Process: E-6

Densitometry: Transmission, Status A

Fields Measured	Computed Values	Transformation Rules	Action	Limits	Spread
Field #1 "D-min"	D-min	R1; G1; B1;	± .02	+ .03	—
Field #2 "LoDen"	Step 3	R2; G2; B2;	± .08	± .10	.08
Field #3 "HiDen"	Step 5	R3; G3; B3;	± .12	± .15	.13
Field #4 "D-max"	D-max	R4; G4; B4;	- .15	- .20	—

NOTES:

- 1) Strips must have at least a 1.25" (30.5mm) leader before outside edge of first target, in order for first target to be detected (see Sec. Two).
- 2) -----> Indicates strip pass direction.

Fuji E-6TD (Manufactured by Fuji)

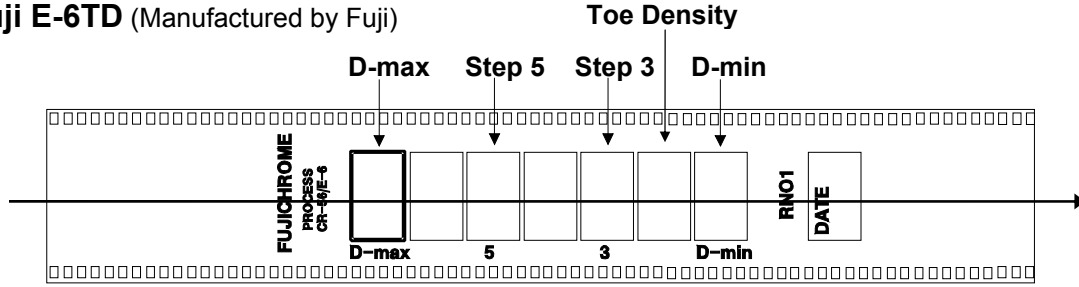

Format: f:E-6TD Process: E-6 Densitometry: Transmission, Status A

Fields Measured	Computed Values	Transformation Rules	Action	Limits	Controls	Spread
Field #1 "D-min"	D-min	R1; G1; B1;	±.02	+ .03	—	—
Field #2 "TD"	Toe Density	R2; G2; B2;	±.05	±.08	±.05	—
Field #3 "LoDen"	Step 3	R3; G3; B3;	±.08	±.10	.08	—
Field #4 "HiDen"	Step 5	R4; G4; B4;	±.12	±.15	.13	—
Field #5 "D-max"	D-max	R5; G5; B5;	-.15	-.20	—	—
	Color Balance	R3-G3 B3-G3	—	—	—	—

- NOTES:**
- 1) Strips must have at least a 1.25" (30.5mm) leader before outside edge of first target, in order for first target to be detected (see Sec. Two).
 - 2) -----> Indicates strip pass direction.

Kodak E-6 (Manufactured by Eastman Kodak)

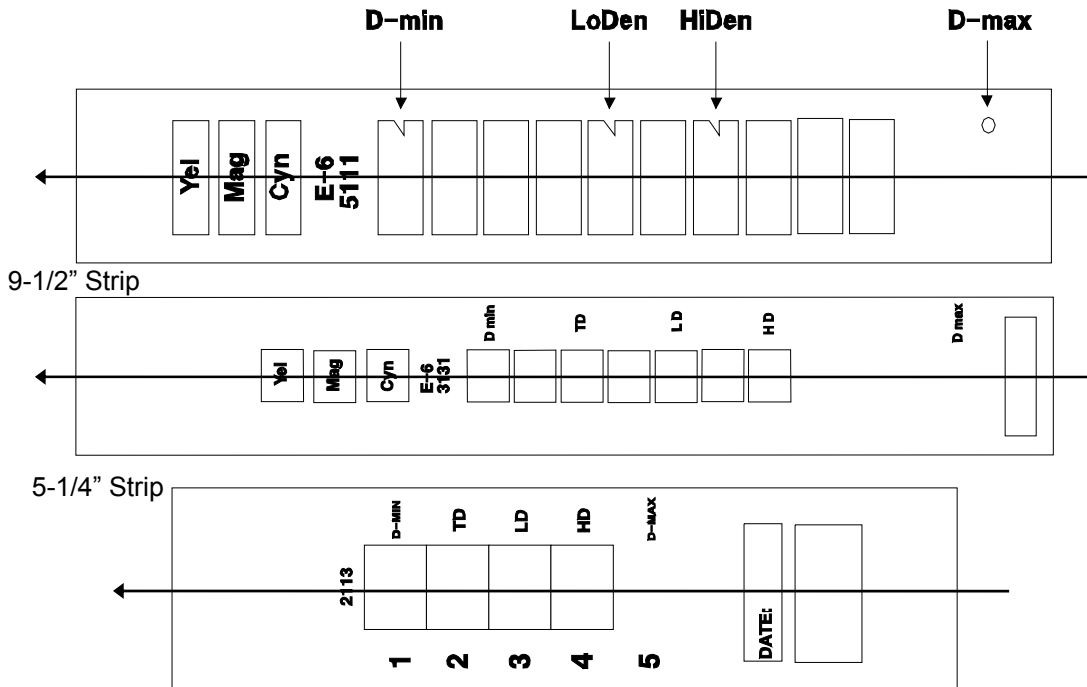

Format: k:E-6 Process: E-6 Densitometry: Transmission, Status A

Fields Measured	Computed Values	Transformation Rules	Action	Limits	Controls	Spread
Field #1 "D-min"	D-min	R1; G1; B1;	±.03	+ .05	—	—
Field #2 "LoDen"	SPEED	R2; G2; B2;	±.08	±.10	—	—
Field #3 "HiDen"	COLOR	R3; G3; B3;	±.12	±.15	—	—
Field #4 "D-max"	D-max	R4; G4; B4;	-.20	-.25	—	—

- NOTES:**
- 1) Strips must have at least a 1.25" (30.5mm) leader before outside edge of first target, in order for first target to be detected (see Sec. Two).
 - 2) -----> Indicates strip pass direction.
 - 3) Yel, Mag, Cyn patches on the Kodak strip are not measured.
 - 4) The 9-1/2" strip must have at least a 1.25" (30.5mm) leader before outside edge of the first color patch (yellow). Do not write on the color patches, they are used for strip recognition purposes.

Kodak E-6 — Use for Q-Lab (Manufactured by Eastman Kodak)

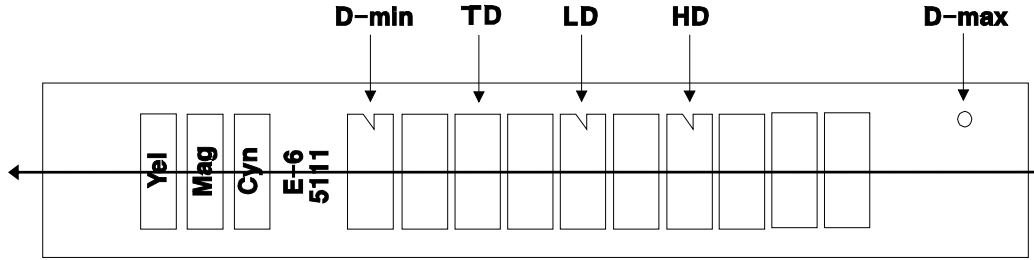

Format: q:E-6		Process: QLab			Densitometry: Transmission, Status A		
					<u>Limits</u>		
<u>Fields Measured</u>	<u>Computed Values</u>	<u>Transformation Rules</u>			<u>Action</u>	<u>Controls</u>	<u>Spread</u>
Field #1 "D-Min"	D-Min	R1;	G1;	B1;	+ .02	+ .03	—
Field #2 "TD"	TD	R2;	G2;	B2;	± .03	± .04	—
Field #3 "LD"	LD	R3;	G3;	B3;	± .04	± .05	—
Field #4 "HD"	HD	R4;	G4;	B4;	± .06	± .08	—
Field #5 "D-Max"	D-Max	R5;	G5;	B5;	- .10	- .13	—
Field #6	LDSpr	R3-G3;	;	B3-G3;	—	± .10	—

NOTES:

- 1) Strips must have at least a 1.25" (30.5mm) leader before outside edge of first target, in order for first target to be detected (see Sec. Two).
- 2) -----> Indicates strip pass direction.
- 3) Yel, Mag, and Cyn patches are not measured.

Kodak Q-Lab (Manufactured by Eastman Kodak)

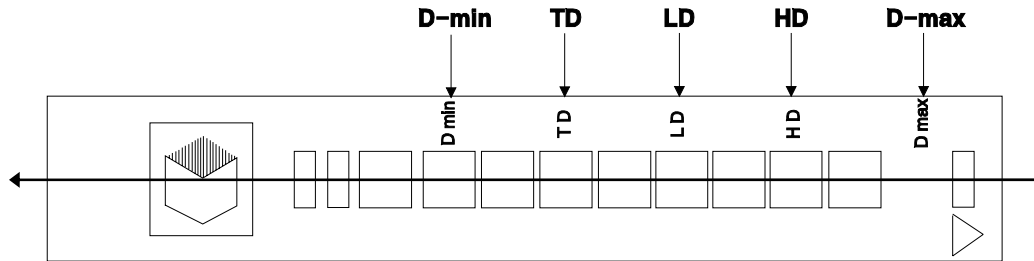

Format: k:Q-LAB		Process: QLab			Densitometry: Transmission, Status A		
					<u>Limits</u>		
<u>Fields Measured</u>	<u>Computed Values</u>	<u>Transformation Rules</u>			<u>Action</u>	<u>Controls</u>	<u>Spread</u>
Field #1 "D-Min"	D-Min	R1;	G1;	B1;	+ .02	+ .03	—
Field #2 "TD"	TD	R2;	G2;	B2;	± .03	± .04	—
Field #3 "LD"	LD	R3;	G3;	B3;	± .04	± .05	—
Field #4 "HD"	HD	R4;	G4;	B4;	± .06	± .08	—
Field #5 "D-Max"	D-Max	R5;	G5;	B5;	- .10	- .13	—
Field #6	LDSpr	R3-G3;	;	B3-G3;	—	—	—

NOTES:

- 1) Strips must have at least a 1.25" (30.5mm) leader before outside edge of first target, in order for first target to be detected (see Sec. Two).
- 2) -----> Indicates strip pass direction.

Ilford P-5 (Manufactured by Ilford)

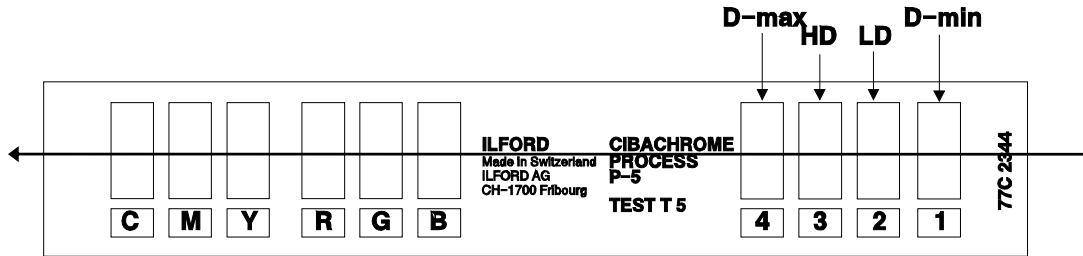

Format: i:P-5 Process: P-5 Densitometry: Transmission, Status A

Fields Measured	Computed Values	Transformation Rules	Limits		
			Action	Controls	Spread
Field #1 "D-Min"	D-min	R1; G1; B1;	±.03	+ .05	—
Field #2 "LD"	LD	R2; G2; B2;	±.08	± .10	—
Field #3 "HD"	HD	R3; G3; B3;	±.12	± .15	—
Field #4 "D-Max"	D-max	R4; G4; B4;	-.20	-.25	—

NOTES:

- 1) Strips must have at least a 1.25" (30.5mm) leader before outside edge of first target, in order for first target to be detected (see Sec. Two).
- 2) -----> Indicates strip pass direction.
- 3) Yel, Mag, Cyn, Red, Grn, and Blu patches are not measured.

3M E-6 (Manufactured by 3M)

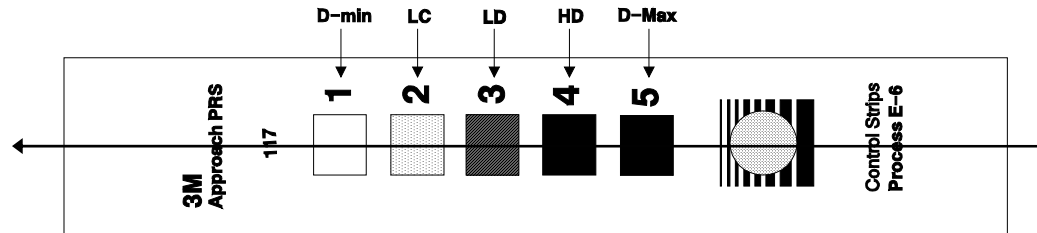

Format: 3M:E-6 Process: E-6 Densitometry: Transmission, Status A

Fields Measured	Computed Values	Transformation Rules	Limits		
			Action	Controls	Spread
Field #1 "D-Min"	D-min	R1; G1; B1;	±.03	+ .05	—
Field #2 "LC"	LC	R2; G2; B2;	±.03	± .05	—
Field #3 "LD"	LD	R3; G3; B3;	±.08	± .10	.08
Field #4 "HD"	HD	R4; G4; B4;	±.12	± .15	.13
Field #5 "D-Max"	D-Max	R5; G5; B5;	-.20	-.25	—

NOTES:

- 1) Strips must have at least a 1.25" (30.5mm) leader before outside edge of first target, in order for first target to be detected (see Sec. Two).
- 2) -----> Indicates strip pass direction.

Printer Balance Requirements

The following rules define the parameters required when measuring printer balance strips using the X-Rite 880/890 series densitometers.

RULE #1: 30.5MM STRIP LEADER

Each Printer Balance Strip should have a minimum of 30.5mm (1.25") from the leading edge of the strip, to the beginning of the first pattern (see example below).

NOTE: If this rule cannot be met, refer to Section Five when measuring strips with less than a 30.5mm leader.

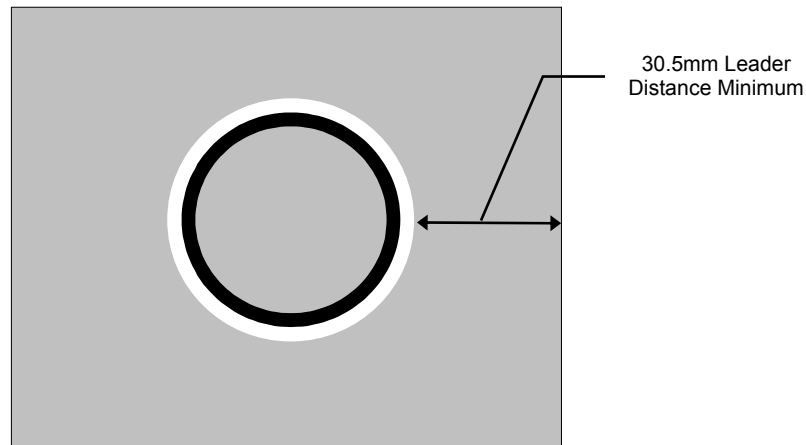

RULE #2: BULL'S-EYE & RING WIDTH REQUIREMENTS

The minimum width of a Bull's-Eye is 19mm (.75"). However, 25.4mm (1") or more is preferred.

The minimum width of a ring is 1.5mm (.06") See example below:

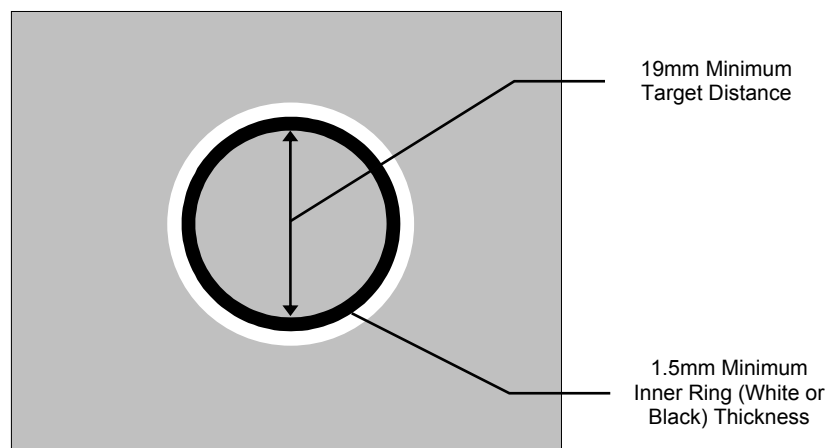

RULE #3: RING/NO-RING

A bull's-eye can be completely encompassed within a ring, or it can be without a ring. However, a bull's-eye **cannot** have a partial ring around it. See examples below:

CAN DO! (as Blk-Eye)

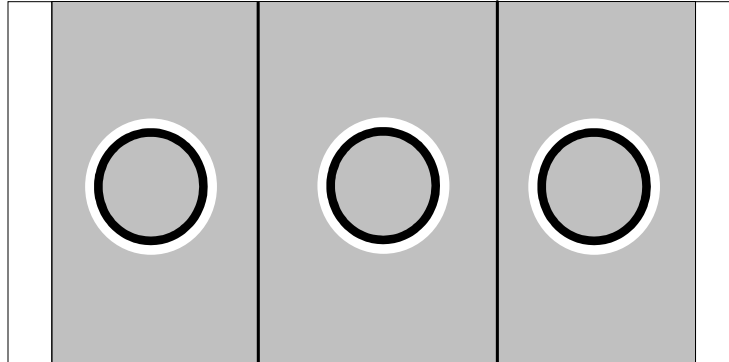

CAN DO! (as No-Ring)

NOTE: A "No-Ring" boundary line must be less than 12.7mm (0.5")

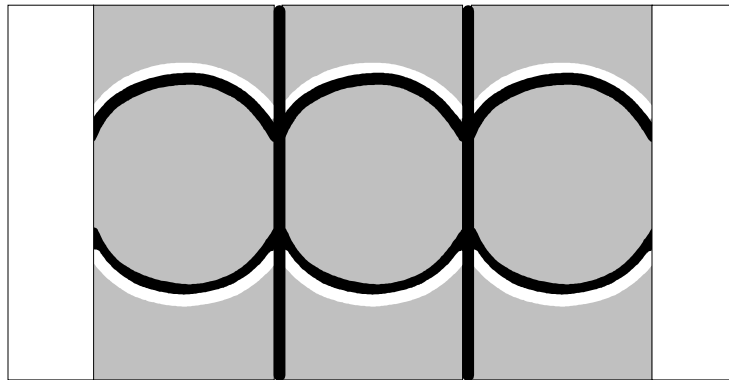

CANNOT DO! (Pattern is neither a complete Blk-Eye or completely a No-Ring.)

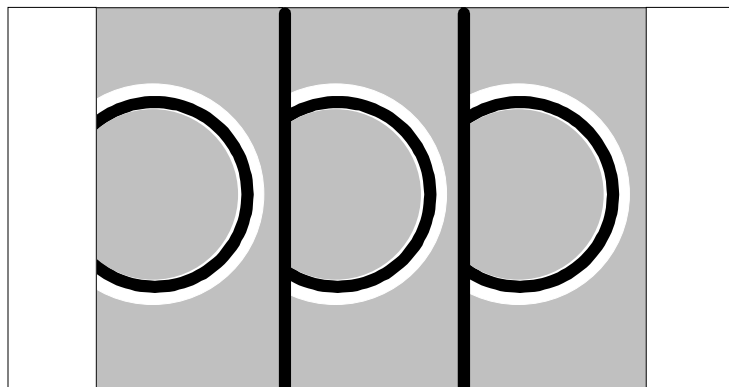

Printer Balance Strip Formats

FORMAT OVERVIEW

The Printer Balance Category in the 880/890 Series densitometer has five basic strip formats. The correct format must be selected before measuring the strip.

The first three generic formats fit most of the printer balance control tools presently used. The remaining formats address specific difficulties found in some of the older bull's-eye formats. The formats are: "Wht-Eye", "Blk-Eye", "No-Ring", "K:3510", and "Small-BE" (Small Bull's-Eye).

Typical Black Bull's-Eye

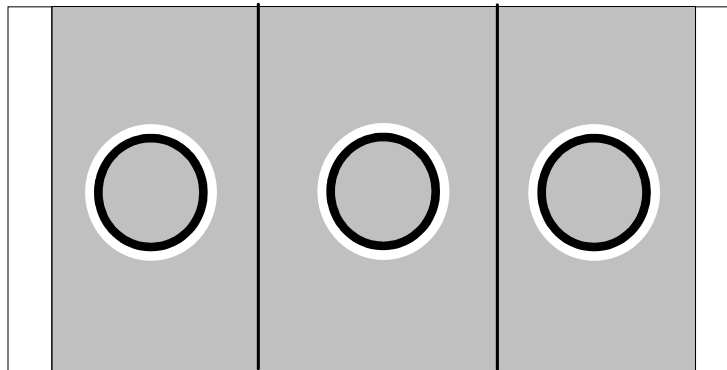

Typical White Bull's-Eye

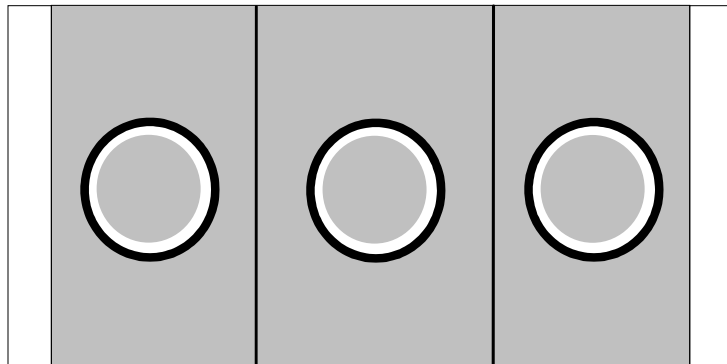

Typical No-Ring Bull's-Eye

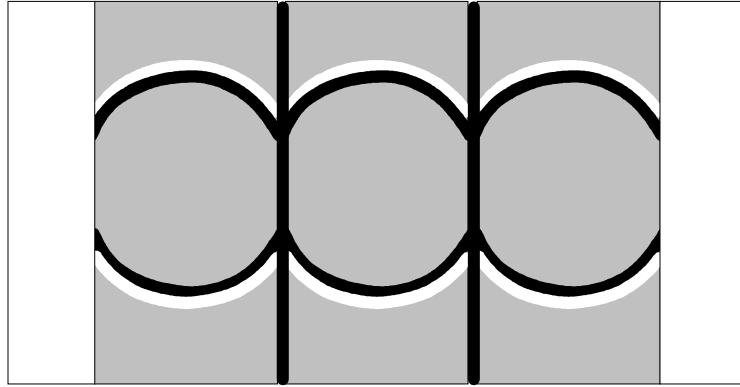

Kodak 3510 Type Bull's-Eye

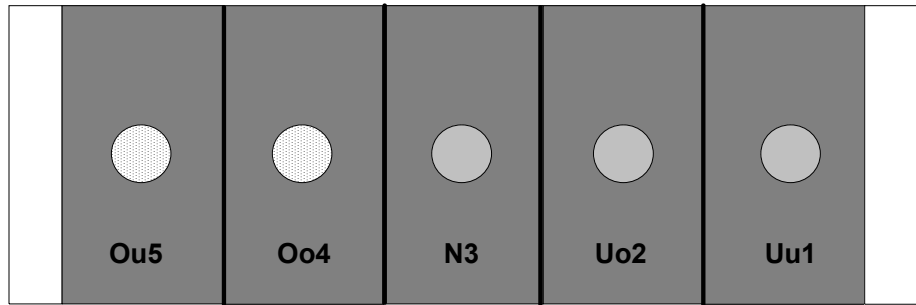

Typical Small Bull's-Eye

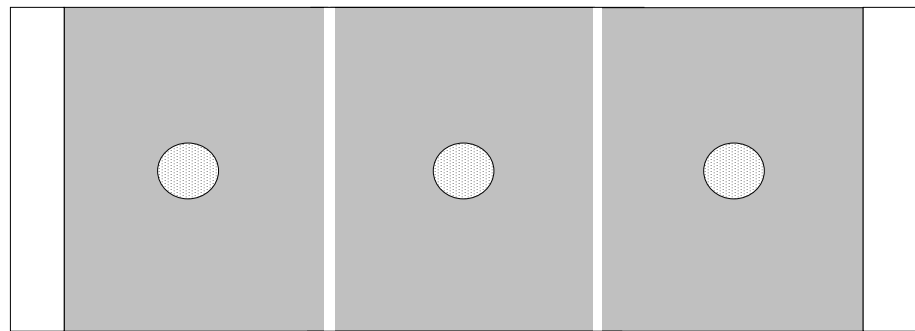

AMPLIFIED FORMAT DESCRIPTION

Black-Eye/White-Eye Explanation

A Bull's-eye is named “Blk-Eye” or “Wht-Eye” on the basis of the color of the inner most ring. If the inner most ring is Black, then the strip type is “Blk-Eye.” If the inner most ring is White, then the strip type is “Wht-Eye.”

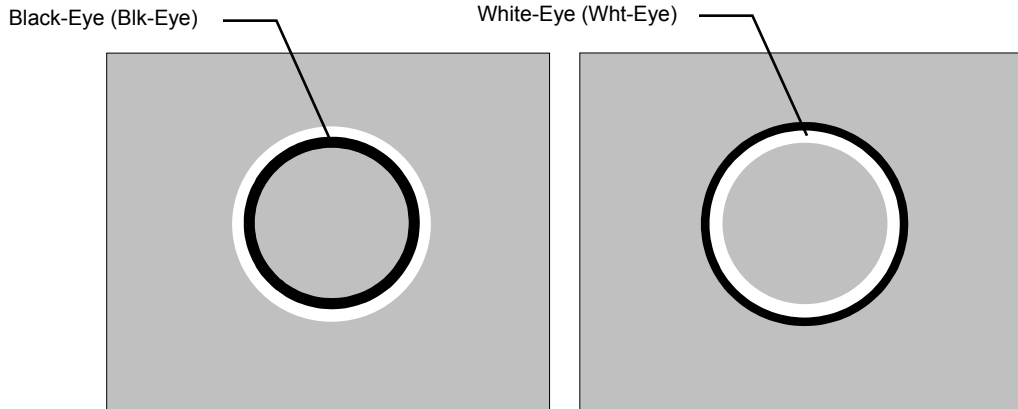

Single Ring (White or Black Bull's-Eye)

If a print has only one ring, then that ring determines the format selection. In addition, if this format is read as a series of more than one print (UNO 1-Pass or 5-Print, for example), the borders separating the prints must be of opposite color as the ring. (i.e., black ring requires white borders.)

If this is not possible, then another way to successfully read this format is to have each print cropped enough so that the distance between the print border and the ring is less than .5" (12.7mm).

Single Black Ring (read as a Blk-Eye)

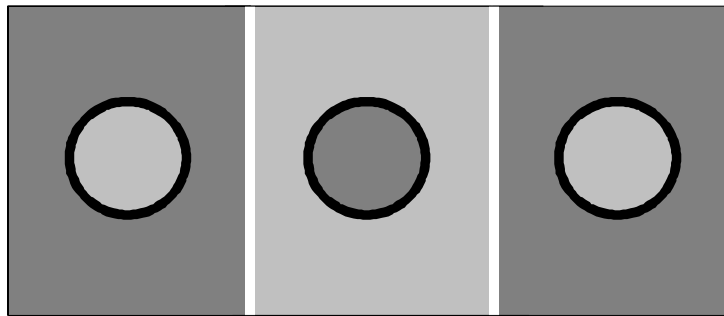

Agfa Built-in Gray Patch (read as a Wht-Eye)

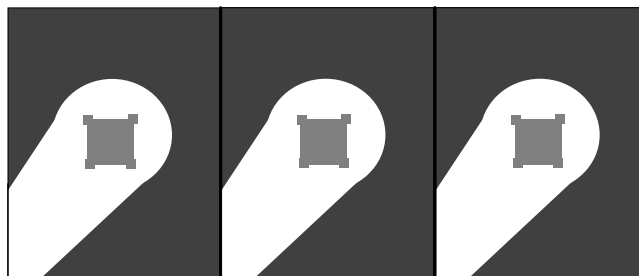

No-Ring Bull's-Eye

The No-Ring format should be used whenever measuring homogeneous regions without rings. This can also include multiple bull's-eye regions that are adjacent to each other, and are cropped such that no rings are measured along the scan path (see Rule #3).

The border between such regions should be no wider than .5" (12.7mm) or no less than 2mm, and can be of any color as long as it is of different densities than the two regions that it separates. White or Black regions will not be recognized as valid printer balance patches. Any leader that is used should be white or black (greater than 1.80D).

Solid Homogeneous Print (read as No-Ring)



Cropped Bull's-Eye (read as No-Ring)

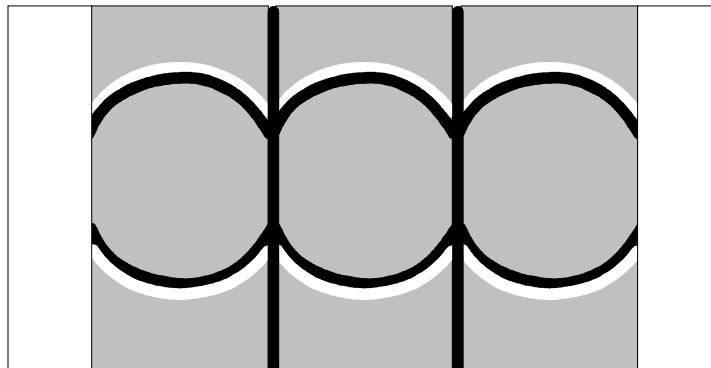

Certain strips can fall into the Wht-Eye/Blk-Eye or No-Ring formats, depending on how they are cropped and printed. For instance, if an Aperion True Balance strip is cropped so that the front and back part of the ring are missing, the strip will fall into the No-Ring format. If the ring is complete, the strip will fall into the Blk-Eye format.

Aperion True Balance (read as Blk-Eye)

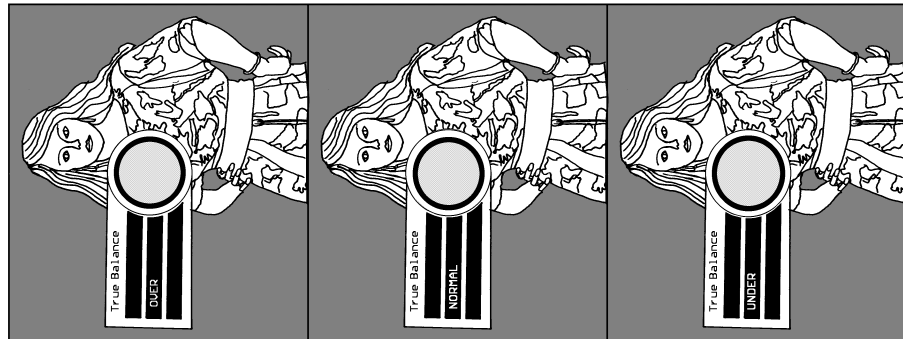

Cropped Aperion True Balance (read as No-Ring)

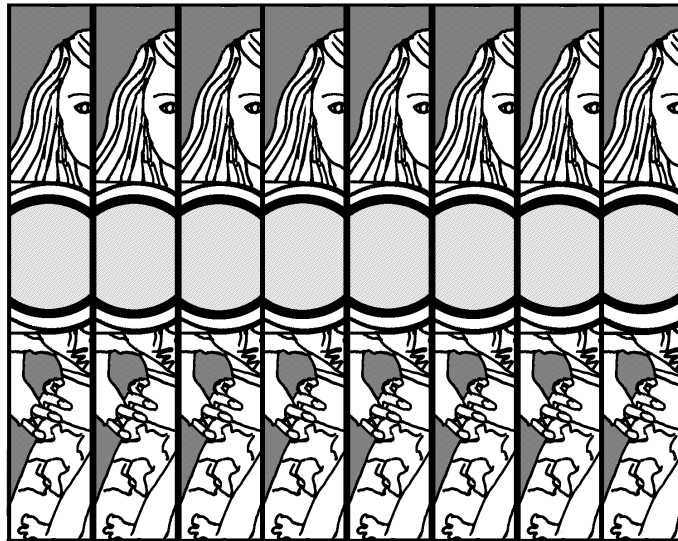

Aperion True Balance 2 (read as Blk-Eye)

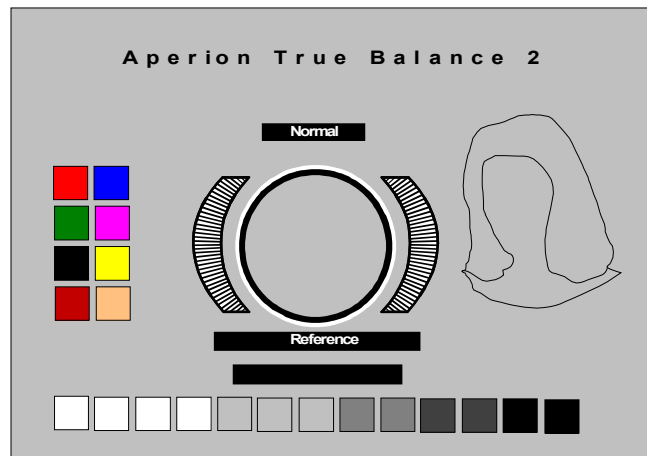

Kodak 3510 Type

The KODAK 3510 type bull's-eye is generally used as a 5-print series (Uu1, Uo2, N3, Oo4, Ou5) by the KODAK 3510 and 2610 family of printers. However, the 2nd, 3rd, and 4th prints of the series are sometimes used as a U.N.O. 3-print series for other printers as well.

The bull's-eye that the unit searches for in this format is often (depending on print size) very close to the specified minimum diameter .75" (19mm) and has a very narrow black ring that may or may not be surrounded by a light halo. Therefore, to provide reliability when recognizing and reading this format, the pattern being read must include some of the darker region on either side of the bull's-eye as well.

As a result, this format of prints should not be cropped to the point where there is less than .75" (19mm) of the darker region on each side of the bull's-eye (see KODAK 3510 Type Bull's-Eye sample in Strip Format Overview Section, for example of safe cropping of this format).

NOTE: The above information also applies to clones of the 3510 format produced by other sources.

Kodak 3510 Type Bull's-Eye

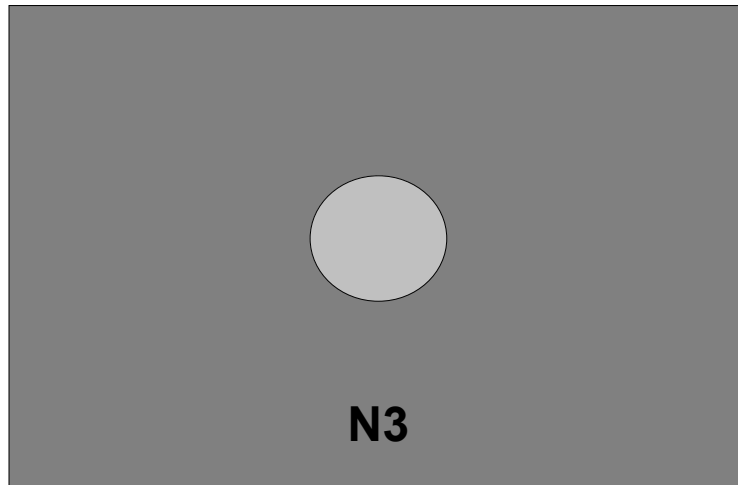

Small Bull's-Eye

The small bull's-eye format provides a way to read a printer balance print with a bull's-eye diameter of less than .75" (19mm). The requirements for this format are that the diameter be at least .38" (9.5mm) and the bull's-eye be surrounded by a region that is of higher density (darker). This format will also allow reading bull's-eyes which conform to the description of "Blk-eye" and "Wht-eye", except that the diameter of the bull's-eye is not less than 0.38".

This format will only read the following print options: "Single", "UNO 3-Pass", or "UNO 1-Pass"). When reading "UNO 1-Pass" (3 prints in one pass), the borders between the prints should be white.

Small Bull's-Eye

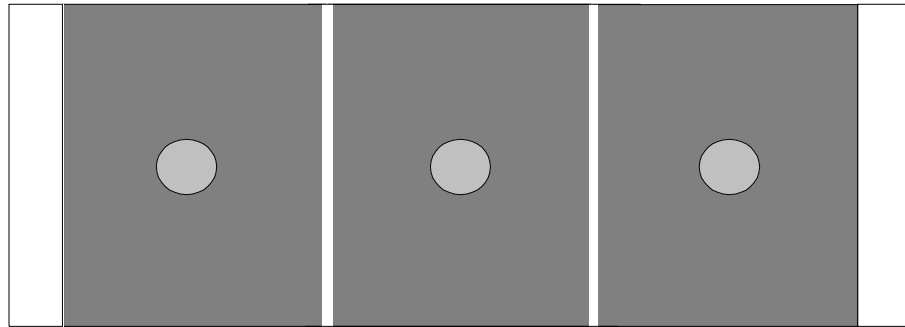

PRINT NUMBER OPTIONS

The Balance Category Strip Formats have six possible options for the number of Bulls-eyes to be read:

- Single** A single balance print. (ex. a single normal print or a reference print.) The maximum length strip that can be read under this option is approx. 13-17 inches.**
- UNO 3-Pass** UNDER/NORMAL/OVER* prints separated (see Strip Formats, Agfa White-Eye for example) and read through the unit in 3 separate passes. The maximum length for each print read under this option is approx. 13-17 inches.**
- UNO 1-Pass** UNDER/NORMAL/OVER prints connected (see Strip Formats, Typical Black-Eye for example) and read in 1 pass through the unit. The maximum length strip that can be read under this option is approx. 26-34 inches.**
- NUO 1-Pass** NORMAL/UNDER/OVER prints connected (see Strip Formats, Typical Black-Eye for example) and read in 1 pass through the unit. The maximum length strip that can be read under this option is approx. 26-34 inches.**
- 5-Print** Uu/Uo/N/Ou/Oo series of prints read through the unit in 1 pass (see Strips Formats, KODAK 3510 for example). The maximum length strip that can be read under this option is approx. 33-43 inches.**
- Multi-↑##↓** Series of prints (0 to 35) read through in 1 pass. Regions measured are labeled by “Reg 1”, “Reg 2”, “Reg 3”, etc. in sequence. The print quantity is selected by pressing the [↑] key to increase or the [↓] key to decrease amount. Setting the print quantity to zero (0) enables a “wild card” mode in which the unit will report how many regions it found on the strip. The maximum length strip that can be read under this option is approx. 50-72 inches.**

** Maximum readable strip length is also affected by the number of visual density changes across the strip. These density changes include the bull's-eyes themselves as print borders, text, scratches, dust spots, etc. Many density changes will reduce the maximum readable length significantly. For example, many scratches and spots on a multi-print strip can reduce its maximum readable length to below 36 inches.

NOTE: When the instruments IO preset is set to “**c:IO#1**” or “**c:IO#2**”, the sequence displayed, measured, and transmitted is N.U.O instead of U.N.O.

Internegative Film Strips

(882/892 only)

TYPE 1 (4 X 5)

The "Type 1" interneg consists of a **Kodak Step Tablet No. 1A** cut between steps 11 and 13, with the two halves mounted side by side in a slide frame (see illustration). Make sure that the full length of the steps 11 and 13 show (i.e., not covered by the inside edge of the slide frame).

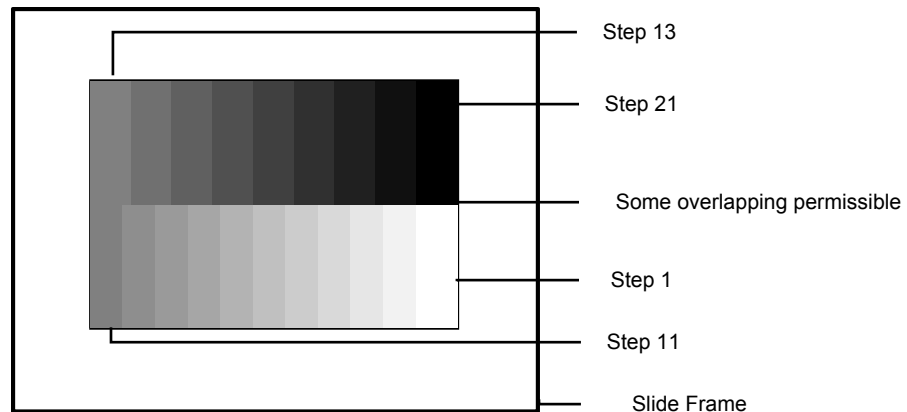

This slide is then projected on to a 4 x 5 interneg such that each step is 1/2" wide. Step 11 and 13 should begin approximately 1/4" in from the edge of the interneg. **Note:** Steps 1 and 21 can go off the other end during projection, this is OK.

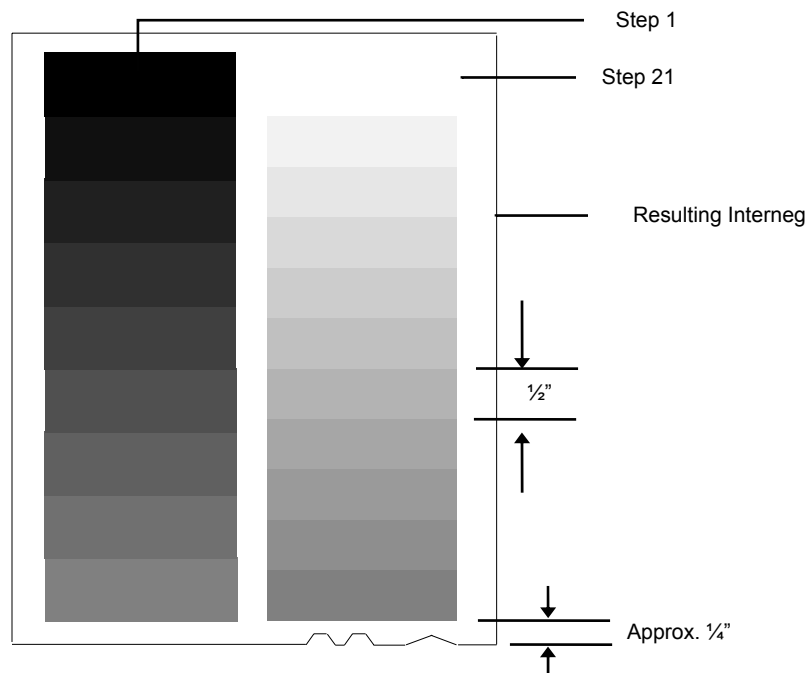

To Measure the Type 1 Strip

1. Center Step 1 over diamond and insert until it rests against the drive rollers.

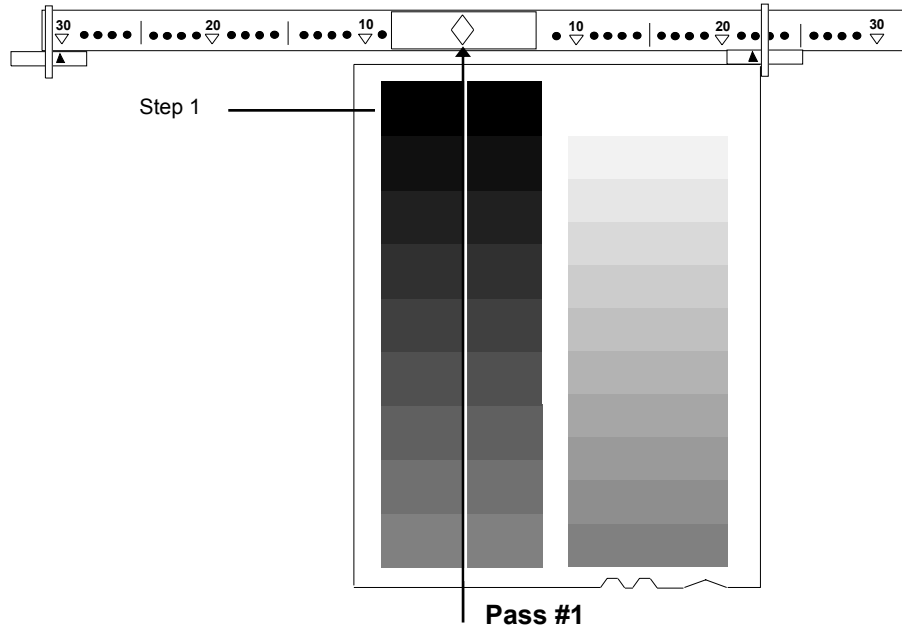

2. Center Step 21 over diamond and insert until it rests against the drive rollers.

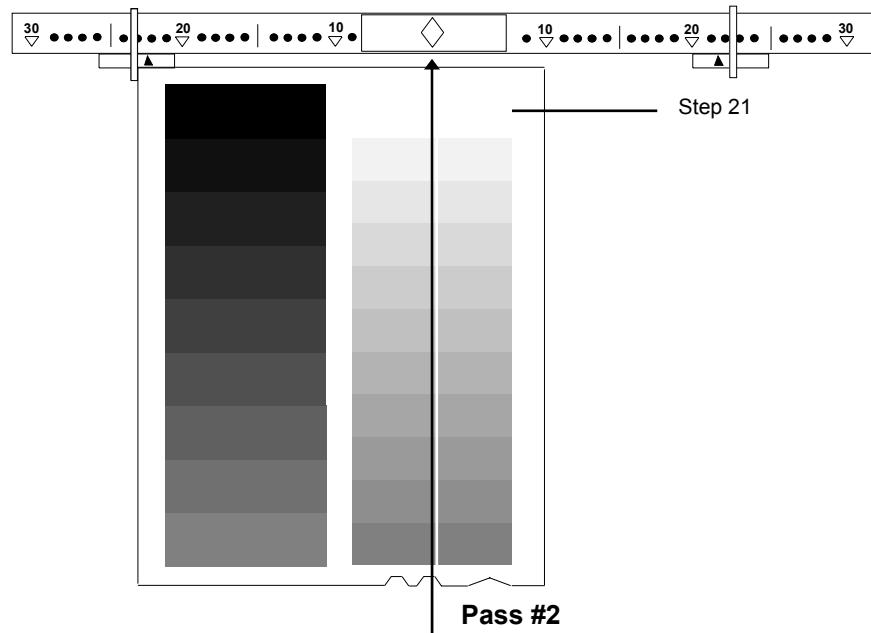

TYPE 2 (35mm)

The Type 2 interneg consists of a **Kodak Step Tablet No. 3** contact printed onto 35mm internegative film. To enable the resulting interneg to be recognized by the 882/892, a piece of opaque tape must be placed over part of step 1 on the step tablet as shown. The tape should be placed such that 0.4" (approx. 3/8") of step 1 is still exposed adjacent to step 2.

To satisfy the leader requirements of the 882/892, a 30.5mm leader should precede the taped area on the resulting interneg.

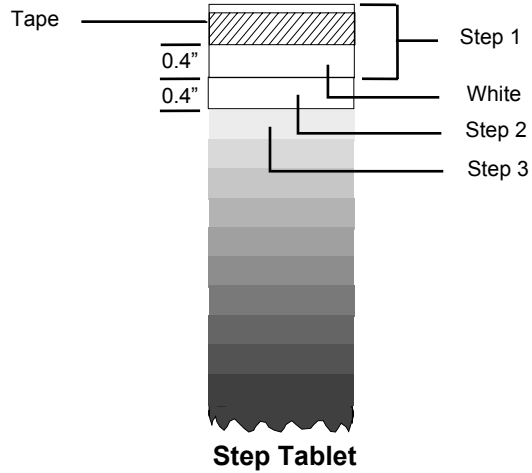

This strip is inserted into the 35mm slot with Step 1 entering first.

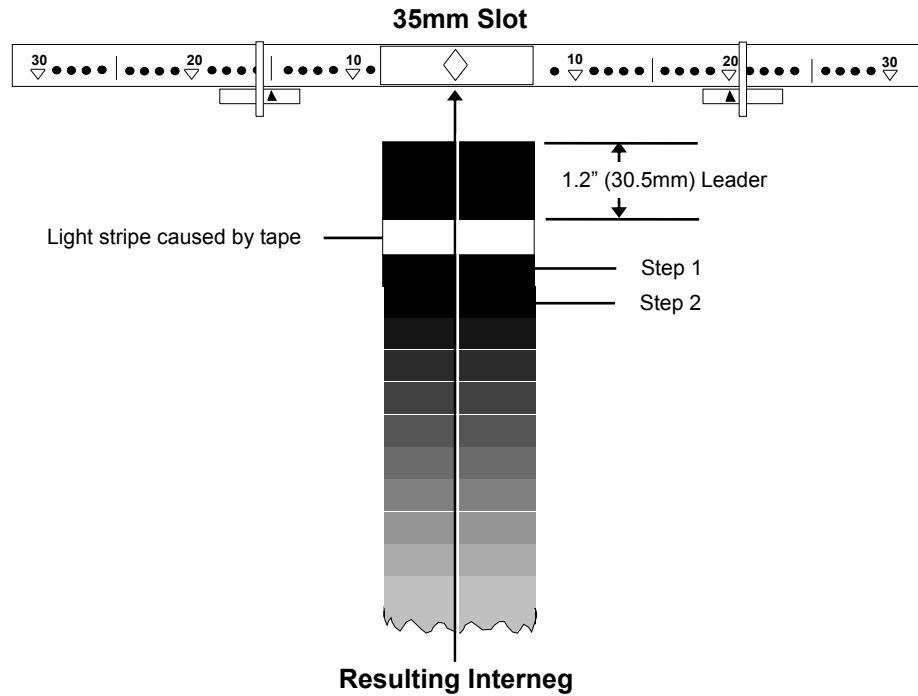

SECTION FOUR

Measuring Leaderless Strips

When preferred use of 30.5mm (1.25") or greater leaded strip is not possible, the following alternate measurement method can be used to reliably read strips.

The following is an example measurement method for a black-eye printer balance, single print strip.

1. Perform normal format and print number selection—refer to your instrument operation manual.
2. Position strip so that the center of the bull's-eye is in line with the middle diamond (never center just the strip, the bull's-eye may be off center). Slide paper guides next to strip.

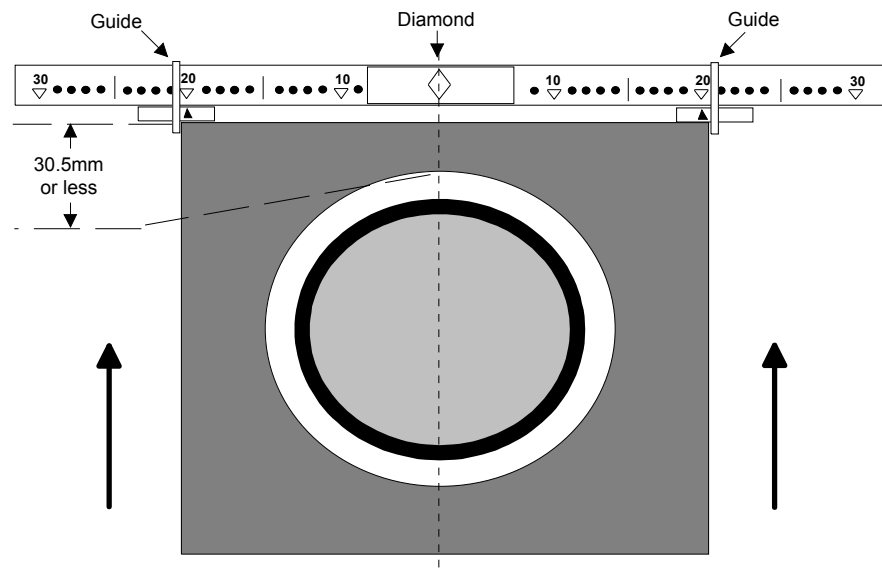

3. Slowly insert strip until read switch is activated, then stop. A “key click” noise will be heard and the display will momentarily go blank.

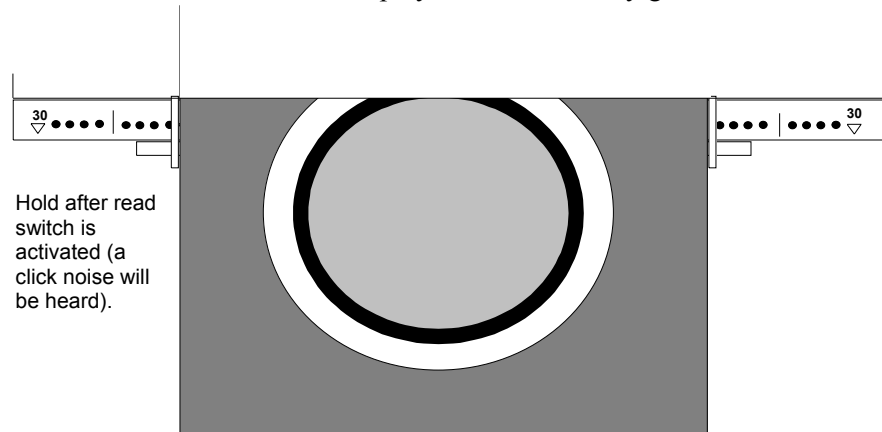

4. When **“SLOWLY ADVANCE STRIP INTO DRIVE”** is displayed, finish advancing strip slowly (approx. 1 - 5 seconds rate) until drive mechanism begins pulling.

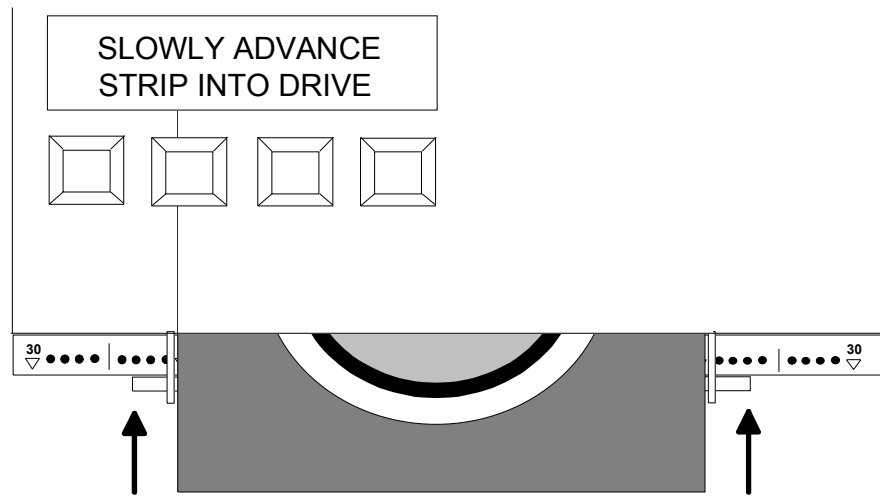

Strip Measurement Error Messages

MESSAGE	REASON	POSSIBLE CAUSE	SOLUTION
INVALID READING, PLEASE RE-READ! or UNRECOGNIZABLE STRIP UNRECOGNIZABLE STRIP or BUFFER OVERFLOW (During measurement)	Unit did not recognize strip.	Wrong strip selection.	Select correct format.
		Strip did not have a 30.5mm leader before first target.	Use strip with leader or refer to Section 5 for leaderless strip readings.
		Strip not inserted in the correct direction.	Refer to Section 1 for strip insertion direction.
		Unit needs calibration.	Calibrate unit. Refer to Calibration Section in operation manual.
		Measurement region not aligned with center diamond, or strip not tracking properly.	Make sure measurement patches are centered with diamond and center line. Usually setting the paper guides to the numbers indicated on the display will take care of tracking problem. Make sure strip feeds straight through unit and does not curve towards one side.
		One or more measurement patches are cloudy, have excessive gradients, or have flecks.	Try re-reading strip again. If error still occurs, process and then measure a new strip.
		Motor drive roller slippage due to restraint or obstruction, or contamination of rollers from reading wet strips.	Remove restraint/obstruction or dry drive rollers with air.
		Lamp failure (weak or bad).	Perform transmission calibration to test lamp. Refer to Calibration Section in operation manual.
A-LIMIT EXCEEDED (during measurement)	Strip measured exceeds Action limit.	Computed values minus aims are greater than the calculated Action limit.	Consult the manufacturers processor manual.
C-LIMIT EXCEEDED (during measurement)	Strip measured exceeds Control limit.	Computed values minus aims are greater than the calculated Control limit.	Consult the manufacturers processor manual.
S-LIMIT EXCEEDED (during measurement)	Strip measured exceeds Color Spread limit.	RGB values are not remaining proportional to each other.	Consult the manufacturers processor manual.
UNRECOGNIZABLE AUTO CAL STRIP! (during reflection calibration)	Unit did not recognize cal strip inserted.	Strip inserted in backwards or upside-down.	Do Not pull on strip during measurement.
		Cal strip is dirty.	Clean cal strip. Refer to unit operation manual.

APPENDIX A

MESSAGE	REASON	POSSIBLE CAUSE	SOLUTION
STRIP RESTRAINED, RE-INSERT STRIP! (during reflection calibration)	Cal strip did not feed consistently.	Strip path is blocked by debris keeping cal strip from feeding properly.	Clean strip path. Refer to unit operation manual.
		Motor drive roller slippage due to restraint or obstruction, or contamination of rollers from reading wet strips.	Remove restraint/obstruction or dry drive rollers with air. If problem persists, return for service
WARNING MOTOR ERROR! (during reflection calibration)	Unit senses motor abnormality.	Strip was pulled out from the back during calibration.	DO NOT pull strip during measurement.
		Motor brush wear.	Return unit for service.
PRESET MEMORY, PLEASE CALIBRATE (during power-up)	Memory data detected in unit is not valid.		Recalibrate unit. Refer to unit operation manual.
WARNING, LAMP MARGINAL! (during transmission calibration)	Lamp output is less than 50% of its peak intensity—but still able to read.	Lamp has aged close to end of its useful life.	Order new lamp and replace at convenient time.
WARNING REPLACE LAMP! (during transmission calibration)	Lamp output is less than required intensity. Measurement accuracy of unit is questionable at this point.	Useful lamp life has expired.	Replace lamp immediately. Refer to unit operation manual.

Generic Strips

The 880/890 series densitometers have the additional capability of reading generic strips. A "generic" strip is any strip that is not pre-defined within the unit. Generic strips are handled differently than normal strips. Instead of trying to recognize a strip read under the generic format, the instrument simply divides the strip into regions. Each region is a patch of uniform color bounded by different colors on each side (a different color can also be a change in visual density). The regions are then viewed and transmitted in the same order that they entered the unit while the strip was being read.

- In order for a particular strip to read reliably (paper or film), the following guidelines should be followed:
- Each region from which data is to be extracted should be at least 0.5" wide.
- Each region should be bordered by a line or region whose density values are different than itself. It is good practice to separate dark regions with white lines at least 1mm wide and white regions with dark lines at least 1mm wide.
- There should be no more than 30 regions on the strip (note that any leader, trailer, and dividing areas larger than approximately 0.35 inches wide may be read as regions).
- There must be at least 30.5mm (1.25") of leader from the leading edge of the strip to the first region to be read.

If you do not wish to have the leader and trailer included in the region data, place alternating black and white strips about 0.1" wide on the leader and trailer to prevent the instrument from finding them as valid regions.

Because of memory limitation within the 880 and 890, reading a generic strip destroys all data previously read in all three channels, including data from previous generic strips. Reading generic strips on the 881, 882, 891, and 892 will not destroy any stored data.

The generic feature is intended for users desiring to read non-standard strips and is especially useful for reading step wedges, which conform to the above guidelines.



Corporate Headquarters - USA

4300 44th Street SE
Grand Rapids, Michigan 49512
Phone 1 800 248 9748 or 1 616 803 2100
Fax 1 800 292 4437 or 1 616 803 2705

Corporate Headquarters - Europe

Althardstrasse 70
8105 Regensdorf
Switzerland
Phone (+41) 44 842 24 00
Fax (+41) 44 842 22 22

Corporate Headquarters - Asia

Room 808-810
Kornhill Metro Tower, 1 Kornhill Road
Quarry Bay, Hong Kong
Phone (+852) 2 568 6283
Fax (+852) 2 885 8610

Please visit www.xrite.com for a local office near you.